

**WARNING: DEVIATION FROM THESE OPERATING INSTRUCTIONS MAY LEAD TO IMPROPER ENGINE/MACHINE OPERATION WHICH COULD CAUSE PERSONAL INJURY TO OPERATORS OR OTHER NEARBY PERSONNEL.**

## **1.0 OVERVIEW**

- 1.1 For help locating subjects in this document, a section index is provided on page 57. A glossary of technical terms is also provided which begins on page 52.
- 1.2 The Altronic DE-2500 controller system is an electronic, microprocessor-based system designed to sense various analog and digital input points to control and monitor industrial compressors. The system is field-programmable using a PC (personal computer) and the supplied DE-2500 terminal program and contains a non-volatile memory to store the setup. Serial communications provide an interface to PC's, PLC's, modems and satellite uplinks for remote communication. A backlit 4x20 LCD character display shows system status, programmed engine/motor and compressor parameters and channel labels. A front mounted keypad serves as the user interface. The DE-2500 provides for both the safety shutdown functions needed to prevent unnecessary damage to remote operated equipment and the closed loop automatic control functions needed to optimize their efficiency of operation. Additionally, the DE-2500 provides for remote data acquisition and supervisory control in a compact, low cost package dedicated to industrial compressor applications. The optimization strategies available for the management of compressor throughput include automatic prime mover speed setting as well as capacity control. On rotary screw compressors, capacity control can be done via suction throttling, or using an internal gas bypass technique employing poppet valves, turn valves or slide valves. On reciprocating compressors, capacity can be controlled using external gas bypass loops or pressure regulation techniques. A wide range of output options, including both analog current loops and digital outputs, are provided to interface with the large variety of actuation systems currently in use. In addition, automatic load limiting based upon prime mover power capabilities or other application specific limitations, such as cooling capacity, are readily implemented. There is also an AUTO START option that is enabled using the terminal program.
- 1.3 The system consists of three main parts: a panel mounted Display Module DE-2500, a Power Supply Module 691122-1, and a Terminal Module 691127-1. These components are interconnected by means of Cable assembly 693115-1.

**WARNING: THE CONTROLLER SYSTEM MUST BE CONFIGURED PRIOR TO USE ON A COMPRESSOR SYSTEM. REFERENCE DE-2500 PI PROGRAMMING INSTRUCTIONS, FOR INSTRUCTIONS DESCRIBING HOW TO CONFIGURE THE CONTROLLER FOR THE SPECIFIC APPLICATION. VERIFY THE PROGRAM IN NONVOLATILE MEMORY (THE EEPROM) PRIOR TO STARTING THE SYSTEM. REFER TO SECTION 10.0 ON HOW TO VIEW THE CURRENT CONFIGURATION.**

## **2.0 DISPLAY MODULE**

- 2.1 The Display Module serves as the user interface for the DE-2500 system. It is in a 6.5" x 6.5" panel mounted enclosure and consists of an alphanumeric 20-character x 4-line backlit LCD display, a 16-key front-mounted keypad, DB-25 D-Sub and DB-9 D-Sub connectors and three pairs of serial port indicators.
- 2.2 The keypad is a sealed membrane unit that contains the familiar STOP, RESET and TEST keys as well as other keys used to navigate through channel status and description, view process screens, and to edit the configuration.
- 2.3 The LCD displays a "home screen" that displays a status line, the speed, the suction pressure and the discharge pressure. A "view screen", which is available by pressing the VIEW key, displays up to eight user configurable analog process labels, values and bargraphs of the corresponding analog inputs. Pressing the VIEW CHANNEL key displays the channel number, its timer status, analog value (if applicable) and the corresponding 20-character user defined label.
- 2.4 The keypad, along with the LCD display, are used to navigate through channel status and descriptions, view process screens, and to view or edit the system's configuration. The ↑UNITS or ↓UNITS or the →TENS or ←TENS keys are used to access channels by increasing or decreasing the channel numbers by one or by ten with each key press. Pressing the NEXT key advances the display to the next screen or item. All menu adjustments are saved in non-volatile EEPROM memory by pressing the ENTER key. The EEPROM memory retains the current configuration during normal operation, after compressor shutdown and a system power-down.
- 2.5 Three pairs of LED's are provided on the back of the Display Module for troubleshooting purposes, one Receive (RX) and one Transmit (TX) LED for each port. The TX LED will flash when the Display Module is transmitting serial communications on the labeled port. The RX LED will flash when the Display Module is receiving serial communications on the labeled port.

## **3.0 POWER SUPPLY MODULE**

- 3.1 The Power Supply Module is made to be rail mounted and is the interface between the Terminal and Display Modules and to other systems. It typically plugs directly into the Terminal Module using the DB-25 connectors and is held together with screws and screw locks.
- 3.2 The Power Supply Module is made to accept up to four industry standard, commercially available 0.6 inch plug-in Output Modules. The Output Modules provide a means of using the DE-2500 controller safety shutdown system status to interface with other systems on the engine/motor and compressor. A typical application would be as a relay or solenoid coil driver. The Output Modules are optically isolated, solid-state switches which are isolated from power supply minus and engine ground. The Output Modules will be in the open (de-energized) condition when the unit is unpowered.

### 3.2 (continued)

Outputs 1 and 2 can be software configured for either normally open (N/O) or normally closed (N/C) operation and have an LED indicator associated with them. Outputs 3 and 4 are pre-programmed normally open for use with the optional Auto start feature. If an Output Module is programmed for normally closed (energized for run), the LED will be ON in the normal run condition and OFF for a fault condition. For Normally open configured modules the LED will be OFF for normal run condition and turn ON for a fault condition.

The standard Output Modules' outputs use the top row of the dual 16-position terminal strip which is marked OUT 1 through OUT 4. Each of these outputs are fused with a replaceable 6.3 amp slow-blow fuse, Altronic P/N 601653. In addition to accepting industry standard Output Modules, a custom Altronic Output Module P/N 691124 is available for tripping ignition powered CD fuel valves and shorting CD ignition shutdown leads upon a fault. When both functions are required, two of these modules are used as follows: OUT 1 slot must be used to trip the fuel valve, and OUT 2 slot must be used to short the ignition. If 12-24 Vdc is lost to the DE-2500 annunciator system, the custom Output Modules will trip the fuel valve and short the ignition shutdown lead. This mimics the "fail-safe" operation of a normally closed Output Module and therefore the LED will be ON in the normal run condition and OFF for a fault condition. In programming the system, these modules are identified by using the IGN/FUEL selection. Terminals IGN+ and IGN- are used to connect the shutdown lead, and FV1 and FV2 are used for the CD fuel valve. A capacitor is included in the Power Supply Module to supply the energy to trip the fuel valve.

- 3.3 The 12-24 Vdc power for the DE-2500 system is applied to the power supply terminals marked (+) and (-) 12 - 24 VDC INPUT POWER. A 6.3 amp replaceable slow-blow fuse protects the system from over currents, and a power LED lights when power is applied to the system.
- 3.4 The external connection for the two serial RS-485 communication ports is on the Power Supply Module terminal strips. Port 2 is for RS-485 serial communication to future Altronic instruments, and port 3 is for RS-485 serial communication to a PC (personal computer) or a PLC (programmable logic controller) to perform remote monitoring or control functions if desired.
- 3.5 Terminals marked IGN IN and PU IN are used by the DE-2500 system to detect either engine rotation or ignition system firings. This input monitors changing signals such as those seen on either the ignition shutdown lead or a magnetic pickup monitoring an engine mounted gear. **THE MAGNETIC PICKUP INPUT MUST BE USED FOR APPLICATIONS ENABLING THE AUTO START FUNCTION.**
- The IGN IN terminal connects to the positive (+) C.D. ignition shutdown lead.
  - The PU IN terminal connects to one magnetic pickup input; the other pickup wire connects to the minus (-) terminal on the Power Supply Module.

NOTE: An installation may use **only one** of the terminals IGN IN or PU IN.

## **4.0 TERMINAL MODULE**

- 4.1 The Terminal Module is made to be rail mounted and is the point of interface between the field sensor wiring and the DE-2500 control system. A removable dual terminal strip is used for the connection of the system to the equipment mounted discrete sensors which may consist of up to 16 normally open or normally closed switches as well as 14 analog transducers. The 16 discrete sensor inputs are similar to previous Altronic DA, DD, and DE annunciator systems and are numbered in the typical annunciator format as 10-17, 20-27. The 14 analog inputs are numbered 30-37 and 40-45 and accept industry standard transducer signals in the range of 0-5 VDC. Connections from the Terminal Module to the Display Module are made using the 693115-x series Cable Assembly.
- 4.2 The DE-2500 is designed to operate with industry standard, voltage or current amplified output transducers in the range of 0 to 5 Vdc or 0 to 25 mA. Four series of transducers are available from Altronic: pressure transducers 691201-x, 691204-x and temperature transducers 691202/203-300, 691212/213-450.
- 4.3 PRESSURE TRANSDUCERS - The pressure transducers, Altronic P/N 691201-x and P/N 691204-x, are packaged in a rugged sealed case with a NPT pressure port, a corrosion resistant media cavity, and a Packard Electric "Metri-Pack" connector. The ranges available are 0-100, 300, 500, 1000, 2000, and 5000 PSIG for the 691201-x series and 0-50, 100, 300, 500 PSIA for the 691204-x series, all of which have an overload rating of 1.5 times full scale without damage. The three wires from the transducer are: +5 volt excitation, +0.5 to 4.5 volt output, and minus return. These three wires connect directly to the back of the Terminal Module using cable assembly P/N 693008-x.
- 4.4 DIFFERENTIAL MEASUREMENTS - On DE-2500 systems above serial number 1525 and programmed using Terminal Software version 2.0 or above, differential pressures or temperatures may be measured by using two consecutive channels. The transducers used to measure differential values must be of the exact same type and range. The first channel of the pair will display the basic parameter it is monitoring and the second channel of the pair will display the numeric difference in engineering units of its value subtracted from the first channel's value. Setpoints for each channel monitor the displayed value of that channel.
- 4.4 TEMPERATURE TRANSDUCER - The temperature transducers, Altronic P/N 691202-300, 691203-300 with a temperature measurement range of +5 to 300°F and the 691212-450, 691213-450 with a temperature range of -40 to +450°F are packaged in a sealed, stainless steel housing with a 5/8"-18 UNF threaded body, and a Packard Electric "Metri-Pack" connector. During configuration the standard calibration for the 691202/203-300 sensor is selected as "dEG1" and the standard calibration for the 691212/213-450 is selected by choosing "dEG2". The three wires from the transducer are: +5 volt excitation, temperature output voltage, and minus return. These wires connect directly to the Terminal Module using cable assembly P/N 693008-x.
- 4.5 THERMOCOUPLE INPUTS - The Terminal Modules above serial number 1525 and programmed using Terminal Software Program version 2.0 or above can also accept industry standard type "J" or "K" thermocouples on inputs 37 - 45. Automatic cold junction compensation is built-in. The units can be configured to °F or °C. Both a high and low setpoint is associated with each channel. The monitor can read type J thermocouples between -76°F and +1382°F (-60°C and +750°C) and type K thermocouples between -76°F and +1472°F (-60°C and +800°C).

## **5.0 MOUNTING**

- 5.1 **DISPLAY MODULE** - Mount the Display Module inside a control panel or to a suitable flat surface so that the display is at a convenient viewing height. A drilling template and mounting dimensions are provided. **NOTE:** Avoid mounting the unit with the LCD display facing direct sunlight. The display operating temperature range is  $-31^{\circ}\text{F}$  to  $+176^{\circ}\text{F}$  ( $-35^{\circ}\text{C}$  to  $+80^{\circ}\text{C}$ ).
- 5.2 **POWER SUPPLY MODULE** - Mount the Power Supply Module in the panel either on the bottom or the side of the main panel. The Power Supply Module is made to be rail mounted onto commercially available 32 or 35 mm DIN mounting rails. It is also made to plug directly into the Terminal Module using the DB-25 connectors and is held together with screws and screw locks. Two end brackets P/N 610751 should be used to keep the modules from sliding off the ends of the mounting rail.

As an alternative, the Power Supply Module and the Terminal Module can be mounted separate from each other on the DIN mounting rails but in the same panel; in this case, a DB-25 male/female cable such as P/N 693115-1 is used to electrically connect these modules. The operating temperature range of the Power Supply Module is  $-31^{\circ}\text{F}$  to  $+176^{\circ}\text{F}$  ( $-35^{\circ}\text{C}$  to  $+80^{\circ}\text{C}$ ).

- 5.3 **TERMINAL MODULE** - Mount the Terminal Module in the panel either on the bottom or the side of the main panel. The Terminal Module and Power Supply Module are made to be rail mounted onto commercially available 32 or 35 mm DIN mounting rails. The Terminal Module is made to plug directly into the Power Supply Module using the DB-25 D-Sub connectors and held together with screws and screw locks. Two end brackets P/N 610751 should be used to secure the modules from sliding off the ends of the mounting rail. The Terminal Module and the Display Module are electrically connected with a DB-25 male/female cable, 693115-x series or equivalent. The operating temperature range of the Terminal Module is  $-31^{\circ}\text{F}$  to  $+176^{\circ}\text{F}$  ( $-35^{\circ}\text{C}$  to  $+80^{\circ}\text{C}$ ).
- 5.4 **PRESSURE TRANSDUCER** - Mount the pressure transducer in the panel or in a manifold or tube off of the engine. Do not expose the pressure transducer to temperatures above  $221^{\circ}\text{F}$ . ( $105^{\circ}\text{C}$ ).
- IMPORTANT:** Pressure transducers will withstand overloads as high as 1.5 times rated pressure. If the overload rating is exceeded, failure may occur. Pressure fluctuations occur in most reciprocating systems; pick the transducer with a rating high enough to prevent overload by peak pressures of pulsations. It is recommended that a pressure snubber be used which will reduce the peak pressure applied to the transducer. The life of the transducer will be extended with the use of a snubber or pulsation dampener.
- 5.5 **TEMPERATURE TRANSDUCER** - Mount the temperature transducer in a thermowell on the engine or machine. The actual sensor is located at the bottom of the transducer body; to ensure accuracy, the tip of the probe should be surrounded by the measured media.
- IMPORTANT:** Do not exceed the absolute maximum rating of the transducers,  $350^{\circ}\text{F}$  ( $176^{\circ}\text{C}$ ) for the 691202/203-300 or  $450^{\circ}\text{F}$  ( $232^{\circ}\text{C}$ ) for the 691212/213-450. Care should be taken to protect the wiring and connectors from contact with hot surfaces.

## **6.0 WIRING (SEE WIRING DIAGRAMS)**

6.1 SYSTEM COMPONENT WIRING - A DB-25 male/female cable, 693115-x series or equivalent, is used to connect the Terminal Module to the Display Module and secured with the cable lock screws. If mounted on the same mounting rail, plug the Terminal Module directly into the Power Supply Module using the DB-25 D-Sub connectors at the ends of the modules and secure them together with the screws and screw locks captive to the connectors. If the Power Supply Module and the Terminal Module are mounted separate from each other (must be mounted in the same panel) a DB-25 male/female cable such as P/N 693115-1 or equivalent is used to connect these modules.

6.2 POWER WIRING - Connect the supply power wires to the 12-24 Vdc input power terminals on the power supply, plus to terminal (+) and minus to terminal (-); power requirement is 12 to 24 Vdc (10 watts max.). The DC- terminal must be connected to panel ground which should be the same as engine ground.

NOTE: This is the return path for normally open sensors and must be connected for proper operation. DO NOT ground this device directly to the ignition system common coil ground.

6.3 SENSOR WIRING DISCRETE INPUTS - The sensor leads connect to the removable terminal strips on the Terminal Module. The terminal numbers correspond to the display numbers which also have a user assigned 20 character label associated with it. The sensor inputs are numbered similar to previous Altronic DA and DD annunciator systems: 10-17, 20-27. The set of terminals labeled R and S are for remote Reset and Stop respectively, with AUTO START disable. With AUTO START enabled, Reset is wired for a start switch. Sensor inputs 10-27 can be user-configurable as class A, class B or class C logic. Any sensor point can be wired for normally open or normally closed operation.

- Normally Open (N/O) sensor switches are wired with one wire to the bottom terminal strip of the respective sensor number and the other to engine ground which should be the same as power minus (-). A short jumper from the bottom terminal to the top terminal must be connected for normally open sensors (see wiring diagrams).
- Normally closed (N/C) sensor switches are wired with one wire to the bottom terminal strip and the other to the top terminal strip of the respective sensor number. Note that the short jumper wire must be removed.
- Remote stop and remote reset are wired the same as the sensor switches, with AUTO START disabled, and can be used with either normally open or normally closed contacts.

Use a wire size of between 16 AWG (max.) to 24 AWG (min.) to connect the sensor switches to the terminal strip connector. Strip the insulation back 3/8"; twist the exposed wires tightly together. Insert the exposed wire completely into the terminal strip and securely tighten the clamping screw. Wires running to sensor switches must be in good condition or replaced with new wires. When running wires, take care not to damage the insulation and take precautions against later damage from vibration, abrasion, or liquids in conduits. An explosion-proof conduit is not required. However; wires should be protected from damage by running them in a protective conduit or in sheaths where appropriate. In addition, it is essential that the following practices be adhered to:

- A. Never run sensor wires in the same conduit with ignition wiring or other high energy wiring such as the AC line power.
- B. Keep secondary wires to spark plugs and other high voltage wiring at least eight inches (200mm) away from sensor and sensor wiring.
- C. Sensor switches may be connected to any passive device using contacts such as standard switch gauges, pressure or level switches. DO NOT connect sensor leads to any voltage producing element.

### 6.3 (continued)

- D. In the case of a field conversion, where sensors have previously been used with Murphy tattletales, it is recommended that the sensors be checked frequently when the DE system is first put into use. Sensor contacts may be burned or pitted from past exposure to ignition system primary voltage. It is advisable to replace such sensors.
- E. If it becomes necessary to check sensor switch to panel wiring with an ohmmeter or other checker, first DISCONNECT the plug-in terminal strips from the Terminal Module. Applying voltage to the DE-2500 system through the sensor leads may damage the device. The area should be tested as non-hazardous before such testing commences.

ANALOG SENSOR WIRING - For each analog monitored point, inputs 30-37 and 40-45, select a transducer - either an Altronic pressure or temperature transducer listed above or one that outputs a signal in the range of 0 to 5 Vdc or 0 to 25 mA. Mount as described above. Use cable assembly 693008-x or similar to wire transducer to the Terminal Module. An internal 5 volt sensor supply (500 mA. max.) is available to power the Altronic transducers; see wiring diagrams. If the 5 volt sensor supply exits the panel, it must be fused with a 0.5 ampere fuse. If 24Vdc powered sensors are used, the 24 volt supply to them must be fused appropriately. Take care not to damage the insulation when installing and take precautions against later damage from vibration, abrasion, or liquids in conduits. In addition, it is essential that the following practices be adhered to:

- A. Never run sensor wires in the same conduit with ignition wiring or other high energy wiring such as AC line power.
- B. Keep secondary wires to spark plugs and other high voltage wiring at least eight inches (200mm) away from sensor and sensor wiring.

6.4 THERMOCOUPLES AND THERMOCOUPLE EXTENSION WIRE - On DE-2500 units serial numbers 1525 or above, the direct measurement of thermocouples can be selected. Grounded or ungrounded type J or K thermocouples may be used. Use thermocouple extension wire of the same type as the thermocouple probe to connect to the terminal module. Use stranded thermocouple wire having a moisture-resistant insulation such as PVC; for higher ambient temperatures, Teflon or B-fibre insulated thermocouple wire is recommended. To ensure that an accurate signal is transmitted to the device, avoid any added junctions, splices and contact with other metals. All unused inputs must be shorted with a short jumper wire between terminals. Take care not to damage the insulation when installing and take precautions against later damage from vibration, abrasion, or liquids in conduits. In addition, it is essential that the following practices be adhered to:

- A. Never run sensor wires in the same conduit with ignition wiring or other high energy wiring such as AC line power.
- B. Keep secondary wires to spark plugs and other high voltage wiring at least eight inches (200mm) away from sensor and sensor wiring.

6.5 OUTPUT SWITCH WIRING - The Power Supply Module is made to accept an industry standard 0.6 inch Output Module. The following modules are available from Altronic:

- 691124 This custom module has two uses: connection to a Murphy fuel valve and directly grounding a C.D. ignition system.  
A) Use in position OUT 1 to connect to a C.D. ignition type Murphy fuel valve. Connect terminals 3 and 8 of the fuel valve to the Power Supply Module terminals marked F1 (FV1) and F2 (FV2).  
B) Use in position OUT 2 to directly ground-out (stop) a C.D. ignition system. Wire the C.D. ignition shutdown lead and ignition ground to the Power Supply Module terminals marked I+ (IGN+) and I- (IGN-) observing the proper polarity for the ignition system. DO NOT connect directly to the ignition system common coil ground.
- 691125 This module is rated for 5-48 Vdc, 5.0 A. and may be used in any of the four output slots OUT 1 through OUT 4.  
NOTE: Use this module if it is desired to interrupt the DC supply to DC-powered ignition systems such as Altronic CD1, CPU-90, II-CPU or DISN.
- 691056 This module is rated for 5-60 Vdc, 2.0 A. and may be used in any of the four output slots OUT 1 through OUT 4.
- 691066 This module is rated for 5-200 Vdc, 0.67 A. and may be used in any of the four output slots OUT 1 through OUT 4.
- 691065 This module is rated for 24-280 Vac, 2.0 A. and may be used in any of the four output slots OUT 1 through OUT 4. NOTE: Other industry standard 0.6 inch modules may be used as required.

6.6 RS-485 COMMUNICATIONS WIRING - There are two RS-485 communication ports available on the DE-2500 system.

- Port 2 is for connection to an optional Altronic DSM device.
- Port 3 is for RS-485 serial communication to a PC (personal computer) or a PLC.

Use a two conductor shielded cable of fine gauge stranded wire and connect the wires for port 2 to the terminals marked "A2" and "B2" and the shield wire to terminal "S2". The wiring for port 3 connects to the terminals marked "A3", "B3" and "S3". Connect to the other communication devices "A" to "A"(-) and "B" to "B"(+). Connect the shield wire to the DE-2500 system ONLY.

6.7 SENSE ROTATION INPUT - Terminals marked IGN IN and PU IN on the Power Supply Module are used by the DE-2500 system to detect either engine rotation or ignition system firings. This input monitors voltage signals such as those seen on either the ignition shutdown lead or a magnetic pickup monitoring an engine mounted gear.

- The IGN IN terminal connects to the positive (+) C.D. ignition shutdown lead.
- The PU IN terminal connects to one magnetic pickup input; the other pickup wire connects to the minus (-) terminal on the Power Supply Module.

**THE MAGNETIC PICKUP INPUT MUST BE USED FOR APPLICATIONS ENABLING THE OPTIONAL AUTO START FUNCTION.**

NOTE: An installation may use **only one** of the terminals IGN IN or PU IN.

## **7.0 HAZARDOUS AREA OPERATION**

7.1 The DE-2500 system is CSA certified for CLASS I, DIVISION 2, GROUPS C and D areas when mounted in a suitable enclosure.

In addition, the following requirements must be met (see NFPA standard no. 493):

1. The low voltage sensor switch wires within the panel enclosure must be kept at least two (2) inches away from other wiring. Run the sensor switch wires leaving the panel in a separate conduit from all other wiring and keep them separate throughout the installation.
2. Wiring to the sensors must have a grade of insulation capable of withstanding an AC voltage of 500 volts RMS.
3. Sensor wires must be run in separate conduits and junction boxes from high voltage wires such as ignition, fuel valve, and other high voltage wiring.

**WARNING: SUBSTITUTION OF COMPONENTS MAY IMPAIR INTRINSIC SAFETY AND/OR SUITABILITY FOR CLASS I, DIV. 2, GROUPS C and D.  
DO NOT DISCONNECT EQUIPMENT IN DIV. 2 ENVIRONMENT UNLESS POWER IS SWITCHED OFF OR THE AREA IS KNOWN TO BE NON-HAZARDOUS.**

## **8.0 KEYPAD DESCRIPTION**

8.1 The DE-2500 controller Display Module contains a sixteen-key sealed membrane keypad which is used to stop, reset and test the system. The user can also view process information screens, view channel specifics, cancel timers, and view and edit pertinent operating parameters.

8.2 STOP - The STOP key is used for a manual stop condition. By pressing the STOP key, the controller activates the configured output modules in the power supply.

8.3 RESET - The RESET key clears all past faulted points and resets all input and output timers to their preset values.

8.4 TEST - The TEST key disables the output modules and allows the user to fault or test the input sensors. Every time the test button is pressed, the test timer resets to its preset value.

8.5 CANCEL TIMERS - The CANCEL TIMERS key cancels all timers.

8.6 VIEW CHAN - The VIEW CHANNELS key allows the user to view the status of any input channel and its user defined label.

8.7 NEXT - The NEXT key allows the user to view the CAPACITY CONTROL & RPM SETPOINT CONTROL screens from the home screen. From the VIEW screen, allows the user to view the next process information screen. From the MENU screens, the next value to be edited.

8.8 VIEW - The VIEW key allows the user to view the process information screens.

8.9 ENTER - The ENTER key is used to accept a selection and to save a new value in memory.

8.10 ESC - The ESCAPE key enables the user to exit any view channels, information or menu screens at any time and return to the previous screen without changing programmed values.

8.11 MENU - The MENU key allows the user to enter the edit menu. The global timers, input class output assignment, output configuration and the time and date may be viewed and adjusted using the MENU key.

8.12 UNITS/TENS - ↑UNITS/↓UNITS keys increase or decrease values by one. The →TENS/←TENS keys increase or decrease values by ten. These keys are used to increase or decrease channel numbers, timers and to move the pointer in the menu screen.

8.13 F1 - Function key F1 displays the hourmeter and servicemeter messages.

8.14 F2 - Function key F2 displays the time and date of the first fault.

8.15 F1 and F2 keys can be used in conjunction with other keys to implement custom functions.

## **9.0 UNDERSTANDING THE HOME SCREENS**

9.1 The "home screens" are described as a series of screens used to display several of the most critical operating parameters on one screen. All of the home screens provide a status word on the upper line, and typically the engine speed on the second line, the suction pressure on the third line and the discharge pressure on the fourth line. Other analog parameters may be programmed in for the second, third and fourth lines.

The status line will read one of the following: TIMERS ACTIVE, RUNNING, TEST XXX SEC, FAULT AL12, MANUAL STOP, AUTO START.

The LCD display always reverts back to one of the home screens after a keypad operation is completed or the operation times out.

9.2 To manually start the engine, press the RESET button. The "TIMERS ACTIVE" message will be displayed and remains until all Class B and Class C inputs have been armed. During the time that the Class B and Class C timers are still active, manually purge and crank the engine.

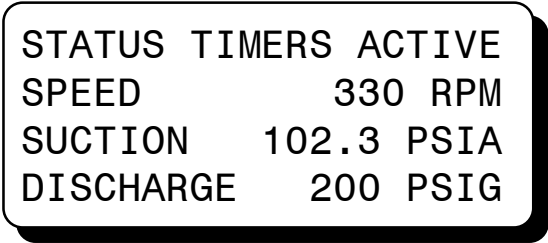

STATUS TIMERS ACTIVE  
SPEED 330 RPM  
SUCTION 102.3 PSIA  
DISCHARGE 200 PSIG

9.3 If the AUTO START option is selected when programming the system from the PC, the display below will appear when the AUTO START sequence begins. The auto start sequence allows for activation of an electrically controlled pre-lube pump for a programmed time period prior to cranking. It is recommended that a warning horn or flashing light be activated by the pre-lube output to inform any personnel which may be present that a cranking attempt is about to begin. After this user programmed time delay, cranking will begin. A user programmable crank disconnect speed switch function will automatically disable the starter at the selected RPM. If the crank disconnect RPM is not reached within a user programmed time period an OVERCRANK FAULT will be generated turning off the fuel and ignition and disabling the starter until a new AUTO START command is received.

STATUS	AUTO START
SPEED	130 RPM
SUCTION	102.3 PSIA
DISCHARGE	200 PSIG

9.4 After all Class B and Class C points have timed out and are being monitored, and if no faults are detected, the home screen will show the "RUNNING" message. This is the screen that will remain under normal operation.

STATUS	RUNNING
SPEED	1000 RPM
SUCTION	102.3 PSIA
DISCHARGE	300 PSIG

9.5 Whenever a programmed servicemeter interval has expired, a \* character will be displayed at the end of the STATUS word on the top line of the HOME screen. If programmed to do so, when using Terminal version 2.0 or above, Digital control output #7 will turn "ON" when any service meter interval has expired. This output can be used to trigger a horn or light or to initiate a service call. The servicemeter will show the hours remaining until a scheduled service function is required. When a service function is overdue, the hours left will display 0. Press the F1 key to display the servicemeter messages.

STATUS*	RUNNING
SPEED	1000 RPM
SUCTION	102.3 PSIA
DISCHARGE	300 PSIG

Press to view message **F1**

HOURMETER / SERVICE MESSAGE NUMBER:	→00
TOTAL HOURS:	8971
OPERATING HOURS	

press to change number **↑ UNITS**

HOURMETER / SERVICE MESSAGE NUMBER:	→01
HOURS LEFT:	100
OIL CHANGE REQUIRED	

press to change number **↑ UNITS**

Proceed through the servicemeter messages to find the required service. The number of hours left until the listed maintenance is due is displayed for each service message. When the hours left reaches zero the \* character is displayed on the home screen status line.

HOURMETER / SERVICE MESSAGE NUMBER:	→02
HOURS LEFT:	0
OIL CHANGE REQUIRED	

press to change number **↑ UNITS**

press to reset hours left **F2**

9.5 (continued)

There are up to eleven user programmable service messages. The desired messages and service intervals are selected when programming the DE-2500 system. The service intervals can only be changed by using the terminal program and the PC. The servicemeter alert can be reset after the required service is performed by pressing the F2 key with the desired message displayed. Each servicemeter message is individually reset.

**9.6 FOLLOW THIS SECTION FOR DE-2500 UNITS PROGRAMMED FROM TERMINAL VERSION 1.0 TO 1.8. FOR DE-2500 UNITS PROGRAMMED FROM TERMINAL VERSION 2.0 OR ABOVE, SEE SECTION 9.7. UNITS WITH SERIAL NUMBERS BELOW 1525 CAN ONLY USE TERMINAL VERSION 1.8 OR LOWER.**

From the RUNNING home screen, the CAPACITY CONTROL home screen is accessed by pressing the NEXT key once. This home screen will display the current controller mode, AUTO or MANUAL, and status of the capacity controller function, including hold position, loading and unloading. Additionally, load inhibit or forced unload conditions caused by secondary control inputs overriding the primary controller output are also displayed.

press  
twice  
to view

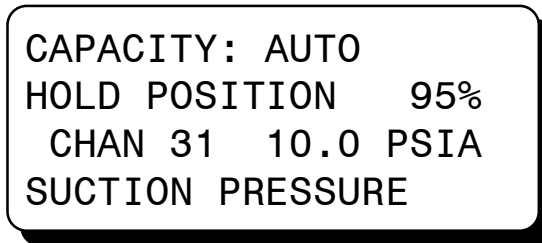

Indicates that the current value of channel 31 which is the Primary control setpoint is within the allowable deadband of the controller and no controller output change is being made at this time.

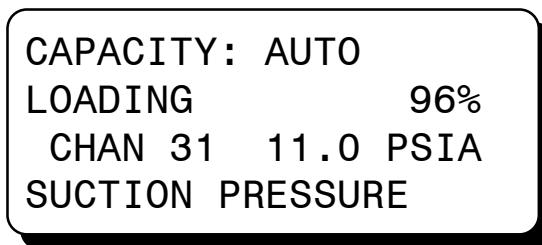

Indicates that the current value of channel 31 is above the desired setpoint by more than the allowable deadband and the output of the controller is being changed to increase the load, which will cause the suction pressure to decrease towards the setpoint.

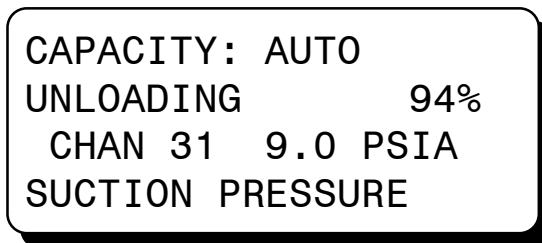

Indicates that the current value of channel 31 is below the desired setpoint by more than the allowable deadband and that the output of the controller is being changed to decrease the load which will eventually cause the suction pressure to increase towards the setpoint.

9.6 (continued)

By programming limits on the secondary control channels, further loading of the compressor can be inhibited until the conditions return to the desired range. Additionally, the option of forcing an unloading of the compressor can also be selected. The control home screen will display the override action and the channel number of the responsible input. The capacity control home screen displays which will appear are shown below. For more detail on primary and secondary controller options see section 22.

**CAPACITY: AUTO**  
**LOAD INHIBIT-34 95%**  
**CHAN 31 11.0 PSIA**  
**SUCTION PRESSURE**

LOAD INHIBIT

Indicates that further loading of the compressor is being inhibited by a secondary control function assigned to channel 34.

**CAPACITY: AUTO**  
**FORCE UNLOAD-36 94%**  
**CHAN 31 10.0 PSIA**  
**SUCTION PRESSURE**

FORCED UNLOAD

Indicates that the compressor is being forced to unload due to a secondary control function assigned to channel 36.

To disable the automatic capacity control and force the controller output to a particular value press the F1 key. The display will indicate that the unit is in MANUAL and the current value of the output. Use the UNITS arrow keys to change the value.

press to change mode

**F1**

**CAPACITY: MANUAL**  
**HOLD POSITION 94%**  
**CHAN 31 10.0 PSIA**  
**SUCTION PRESSURE**

press to change value

**↑**  
**UNITS**

9.6 (continued)

From the RUNNING home screen, the RPM SETPOINT CONTROL screen is accessed by pressing the NEXT key twice. This home screen will display current speed control, AUTO or MANUAL, and the status. There are three possible status messages displayed: HOLDING, INCREASING, AND DECREASING.

press  
twice  
to view

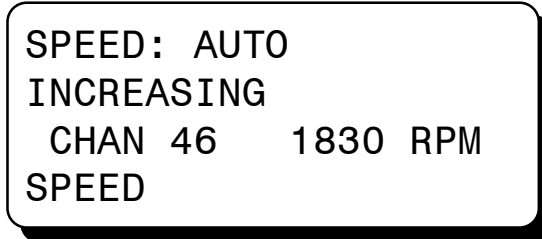

press to  
change  
mode

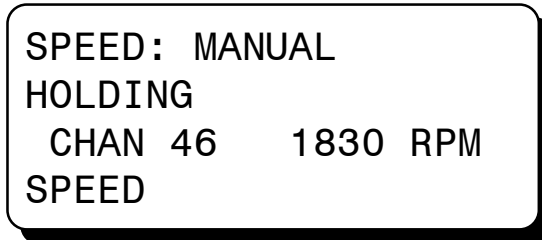
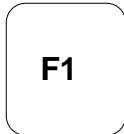

press to  
change  
value

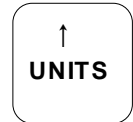

**9.7 FOLLOW THIS SECTION FOR DE-2500 UNITS PROGRAMMED FROM TERMINAL VERSION 2.0 OR ABOVE. FOR DE-2500 UNITS PROGRAMMED FROM TERMINAL VERSION 1.8 OR BELOW, SEE SECTION 9.6. DE-2500 UNITS WITH SERIAL NUMBERS ABOVE 1525 MAY BE PROGRAMMED USING EITHER VERSION OF TERMINAL SOFTWARE, VERSION 1.8 OR 2.0.**

From the home screen, the CONTROL LOOP #1 screen is accessed by pressing the NEXT key once. CONTROL LOOP #1 is a closed loop PID controller which is assigned to the analog value measured by channel 30. This can be virtually any pressure, temperature, valve position or other equipment parameter which can be expressed as an analog value from 0 to 5 volts. Some typical controlled values would be the discharge pressure of a compressor, the intake manifold pressure of an engine, the temperature of a cooling system or the chemical composition of a process output. The first line of the display will indicate the input channel/output channel and the current value of the controlled parameter. The next line shows the desired value, the setpoint, of the controlled parameter. The third line shows the current settings of the loop tuning values; the P: 45% indicates a proportional band setting of 45%, the I:1s indicates an integral term of 1 second, and the D:450m indicates a derivative value of 450 minutes.

press  
to view

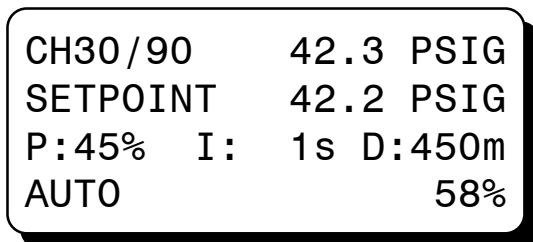

9.7 (continued)

The current values of the control loop can be viewed at any time, however, to change these values, a specific key sequence must be entered first. **To unlock the control loop values, press the keys F2, F1, and ENTER in that order.** A small arrow will appear next to the value to be changed. Use the arrow keys to change the value and the ENTER key to accept the new value. As the ENTER key is pressed, the controller will begin controlling to that value and the cursor advances to the next value. To disable the optional automatic control and force the controller output to a particular value after unlocking the control, press the F1 key. The display will indicate that the unit is in MANUAL and the current value of the output. Use the UNITS arrow keys to change the setpoint value.

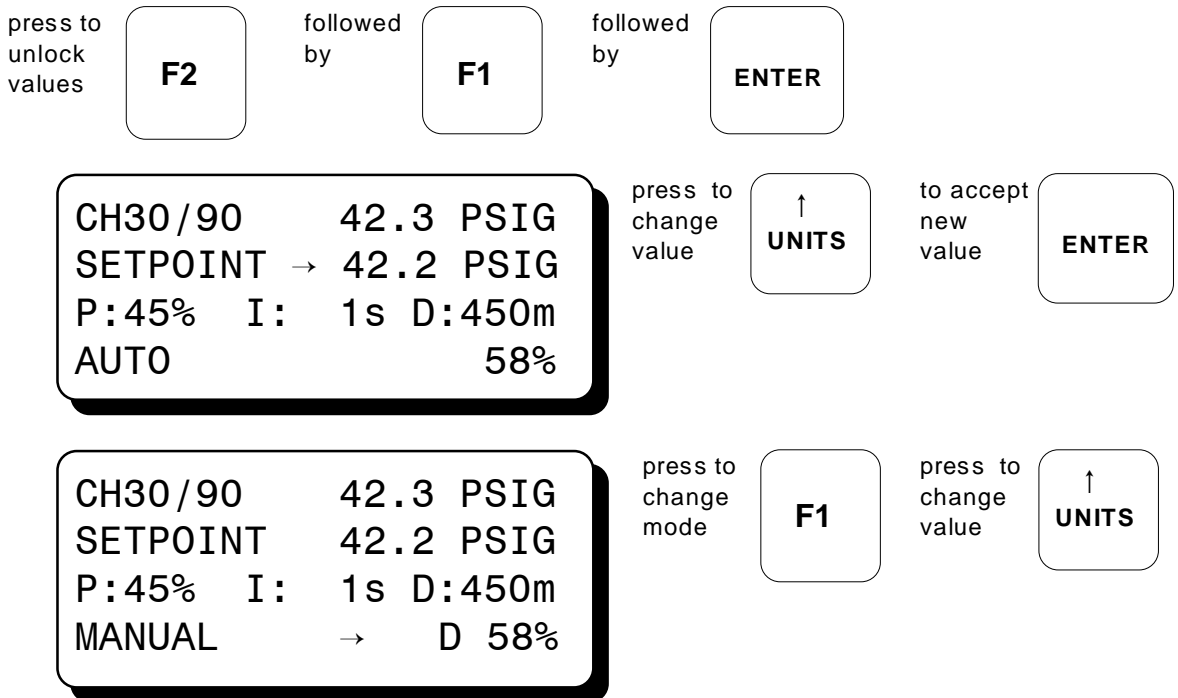

The second control loop, CONTROL LOOP #2, is accessed by pressing the NEXT key twice from the HOME screen. CONTROL LOOP #2 is a second independent PID loop (like LOOP #1) and can be programmed to control based upon the analog input of Channel 31. In addition to controlling the 4-20 mA output, based upon the channel 31 analog voltage, a closed loop control of the input frequency being measured by the RPM input Channel 46 is also possible. The selection of which channel acts as the control input is made when programming the unit from the PC Terminal program. In order to change the tuning values for LOOP #2 from the LOOP #2 screen, the same key sequence as for LOOP #1 is used.

9.7 (continued)

The screens which will appear for LOOP #2, depending upon which program options are used, are shown below.

CH31/91	42.3 PSIG	press twice to view	<b>NEXT</b>	or
SETPOINT	42.2 PSIG			
P:45% I: 1s D:450m				
AUTO	58%			

CH31/91	1199 RPM	press twice to view	<b>NEXT</b>
SETPOINT	1200 RPM		
P: 45% I: 1s D:450m			
AUTO	58%		

9.8 In addition to the two 4-20 mA analog control loop outputs, the DE-2500 offers a pulsed digital output control option on Digital outputs #1 and #2 for use with solenoid valves or motor valves. This option is referred to as PULSE CONTROL and allows for closed loop control of the variable measured by the analog voltage measured by input channel 30. On DE-2500 units above serial number 1525 and programmed using terminal software 2.0, the pulse control is attached to channel 32, allowing for three independent control loops. When PULSE CONTROL is used, Digital output #1 is used to open a valve or to increase the output when it is "ON". Digital output #2 is used to close a valve or decrease the output when it is turned "ON". A decision of which output to activate and for how long is made once per cycle. A maximum "ON" time limit is selected when programming the unit from the PC Terminal Program. To change the control variables for PULSE OUTPUTS, select "EDIT CONTROL VALUES" from main menu and press the ENTER key. The edit control values menu is shown. The arrow points to the "EDIT PRIM. CONTROL".

EDIT SETPOINTS	press to edit pulse controls	<b>ENTER</b>
→EDIT PRIM. CONTROL		
EDIT PID DEADBAND		

CONTROL	35.0 PSIG	press to change value	<b>↑ UNITS</b>	press to accept or go to next value	<b>ENTER</b>
CYCLE TIME →	2 s				
PROP. BAND	40 %				
DEAD BAND	0.5 PSIG				

9.9 On some applications, in addition to all of the standard PID control tuning, it may be desirable to allow for a small controller deadband in order to promote system stability. To set or edit the PID deadband value, select this function from the Menu as shown.

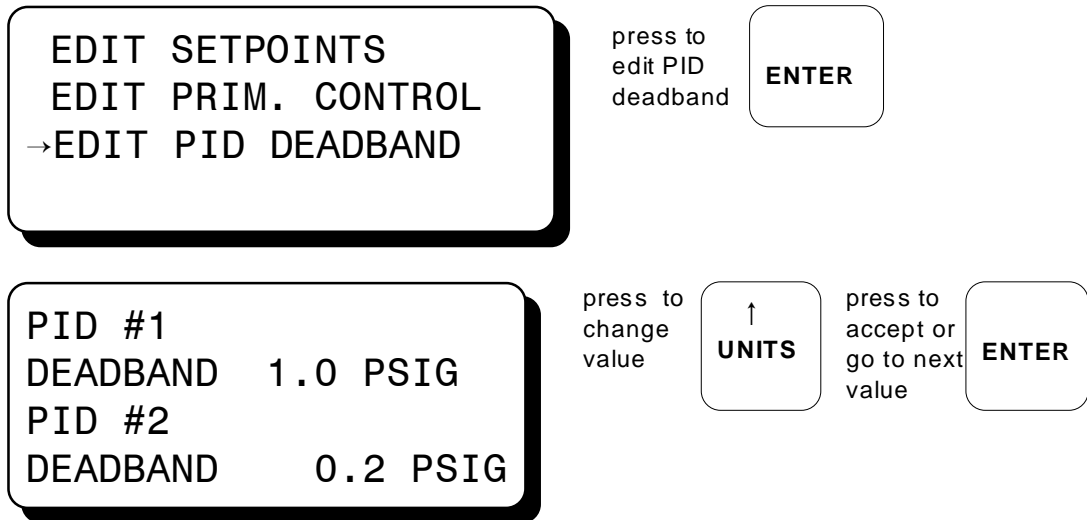

9.10 The TEST home screen is entered by pressing the TEST key. The TEST mode disarms all outputs and may only be entered from the RUNNING mode. The test time remaining is shown on the top line. See section 13.0 TEST MODE SCREENS for more information.

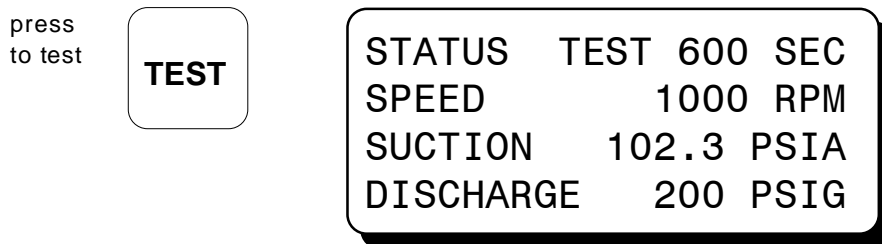

9.11 If a fault condition occurs, the “FAULT” message for the first faulted channel will appear on the display and will remain there until it is acknowledged. The numbers one through two, after “AL” (alarm), shows the output switch that is faulted. To again view the first fault screen, press the VIEW CHAN key. If all of the faulted sensors have been cleared and the RESET key is pressed, the class B, C and output timers will reset and the display will return to the TIMERS ACTIVE home screen.

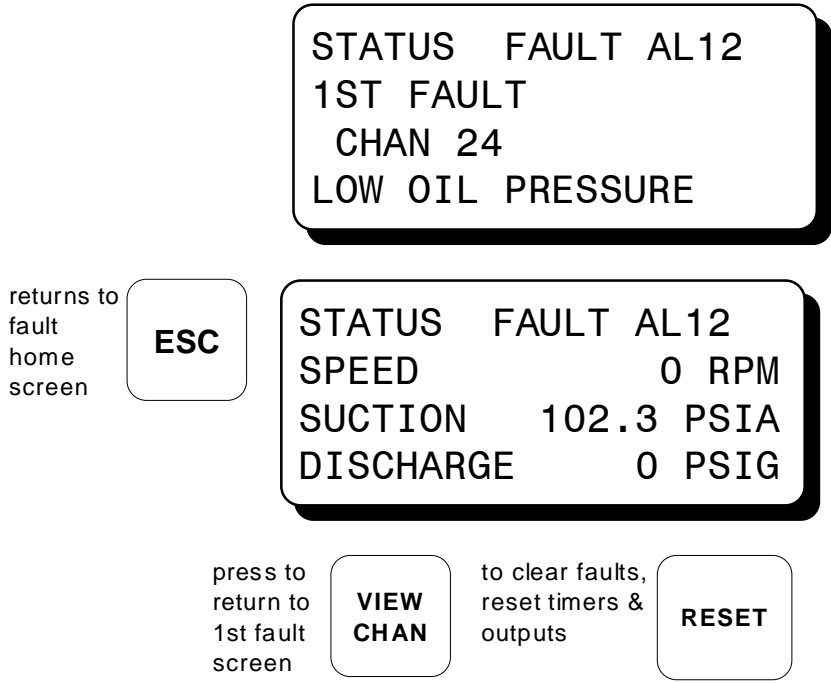

NOTE: The reset function can also be implemented by using the external hardware. RESET / AUTO START input available on the Terminal Module. The behavior of the Controller and display will be determined by the programming selections made when configuring the unit.

9.12 The “MANUAL STOP” message will supersede all of the above home screens if the STOP key is pressed.

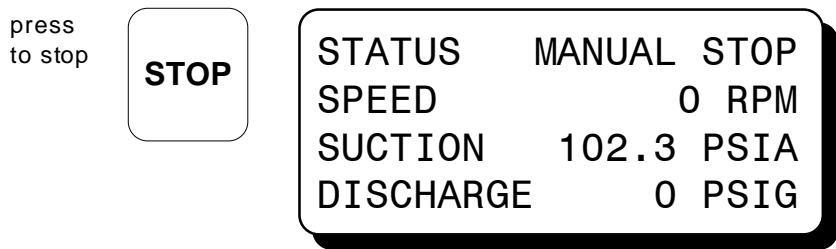

NOTE: The stop function can also be implemented remotely by using the external STOP input available on the Terminal Module. The behavior of the Controller and display will be identical to that obtained by pressing the local STOP key on the Display Module.

## 10.0 VIEW PROCESS INFORMATION SCREENS

- 10.1 The process information screens can be accessed from any of the home screens (except the test home screen) or from the view channel screen by pressing the VIEW key. There are four process screens: screens one and three each display up to four user programmed process variables; screens two and four display an analog bargraph associated with the previous process variable screen. Thus, up to eight process variables can be displayed both digitally and in bargraph format.

The analog values are monitored by a microprocessor on the terminal board and are configured by using a PC and the terminal program . The bargraph end points are set by the low and high setpoints of the safety shutdown function. Unused channel screens will not be displayed.

from

STATUS	RUNNING
SPEED	1000 RPM
SUCTION	102.3 PSIA
DISCHARGE	200 PSIG

press



NOTE: Screens one and two display in digital and bargraph form the first group of four selected analog inputs.

then at

SUCTION	22 PSIA
DISCHRG	100 PSIG
FILTR	10 PSIA
BOP	110 PSIG

press to  
view  
bargraph  
screen



then at  
bargraph  
screen

SUCTION	L	H
DISCHRG	L	H
FILTR	L	H
BOP	L	H

press to  
view  
next  
screen



NOTE: Screens three and four display in digital and bargraph from the second group of four selected analog inputs.

then at

TEMP 1	180	° F
TEMP 2	250	° F
TEMP 3	300	° F
TEMP 4	320	° F

press to  
view  
bargraph  
screen



then at

TEMP 1	L	H
TEMP 2	L	H
TEMP 3	L	H
TEMP 4	L	H

press to  
view next  
process  
screen



press  
to  
escape



Note: On DE-2500 units programmed using Terminal Program 2.0 or above two additional process screens are available, to allow the display of up to 12 process channels.

## **11.0 VIEW CHANNEL STATUS SCREENS**

- 11.1 Use the VIEW CHAN key to enter the view channels screens. Once in the VIEW CHAN mode, the user can view any channel's details.
- The first line will be the controller system status; "TIMERS ACTIVE", "RUNNING", "FAULT AL12", or "MANUAL STOP".
  - The second line shows whether the input point is "ARMED" or "NOT ARMED". Class A points will always be armed; class B points become armed only after their timers have timed out. Class C points arm when cleared or when the timer times out.
  - The third line shows the channel number and an analog value of that input; if configured for that channel.
  - The fourth line shows the user entered 20 character channel description.

Upon pressing the view channel key, channel 10 will be shown. The UNITS and TENS keys allow the user to quickly navigate through the controller channels. Use the ↑ UNITS or ↓ UNITS keys to increase or decrease the viewed channel by one. Use the → TENS or ← TENS keys to increase or decrease the viewed channel by ten. To exit the VIEW CHAN mode, press the ESC key. After five minutes with no keypad activity, the display will revert back to the current home screen.

11.1 (continued)

from current  
home screen

STATUS TIMERS ACTIVE  
SPEED 330 RPM  
SUCTION 102.3 PSIA  
DISCHARGE 200 PSIG

press



to see channel  
20 from channel  
10

STATUS TIMERS ACTIVE  
NOT ARMED  
CHAN 10  
ENGINE OIL PRESSURE

press

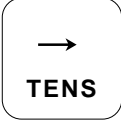

to see channel  
21 from channel  
20

STATUS TIMERS ACTIVE  
ARMED  
CHAN 20  
MANIFOLD PRESSURE

press

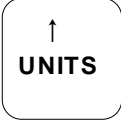

to see channel  
40 from  
channel 21

STATUS TIMERS ACTIVE  
NOT ARMED  
CHAN 21  
LB MANIFOLD PRESSURE

## 11.1 (continued)

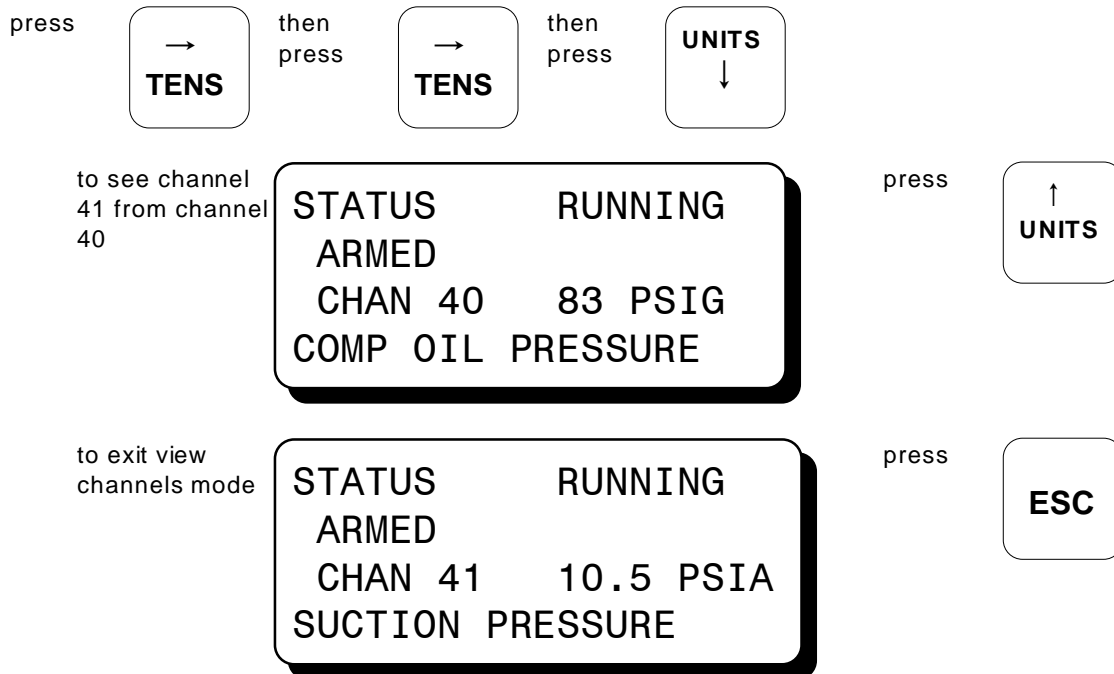

## 12.0 SHUTDOWN OR FAULT STATUS SCREENS

- 12.1 With the engine running and the controller system monitoring points, if a fault occurs, the display will show the first fault detected. The phrase "1ST FAULT" and "AL12" will be displayed; "AL1" is for the first output, "AL12" is for outputs one and two. The output or outputs configured for that channel will trip. The first fault will stay displayed on the screen until it is acknowledged by one of the keypad keys RESET or ESC. Use VIEW CHAN key to view the status of all channels.

After all of the current faulted channels are displayed, the display will revert back to the first fault. If no class A sensors are faulted, pressing the RESET key will clear all displayed faults and return the display to the timers active home screen. All class B and C input timers and the output timers will be reset. Pressing the ESC key when the fault screen is displayed will return the display to the fault home screen. To again view the "first fault" from the fault home screen, press the VIEW CHAN key.

Upon a fault,  
the first fault is shown.

STATUS	FAULT	AL12
1st	FAULT	
CHAN	24	
HIGH	LIQUID	LEVEL 1

## 12.1 (continued)

to reset  
timers &  
outputs

RESET

```
STATUS TIMERS ACTIVE
SPEED           330 RPM
SUCTION        102.3 PSIA
DISCHARGE      200 PSIG
```

or press  
reset to  
reset  
outputs

RESET

or press  
esc for  
fault home  
screen

ESC

- 12.2 When a fault occurs on an analog channel 30-47 monitor, a “HIGH” or “LOW” indication will additionally be displayed as to whether the point faulted on a high or low setpoint.

A high setpoint faulted  
on an analog input.  
The analog value and  
“HIGH” are displayed.

```
STATUS FAULT AL12
1st FAULT HIGH
CHAN 42 300 °F
HIGH DISCHARGE TEMP
```

press  
reset to  
clear  
fault

RESET

## 13.0 TEST MODE SCREENS

**WARNING: TEST MODE DISARMS ALL OUTPUTS. ACTUAL FAULTS WILL DISPLAY BUT WILL NOT TRIP THE SYSTEM ALARM AND SHUTDOWN OUTPUTS. USE MANUAL STOP FOR EMERGENCY SHUTDOWN.**

- 13.1 The test mode is used for testing sensors without tripping the outputs. The controller system stays in the test mode for a preset timed period. To enter the test mode, make sure the home screen status line says “RUNNING”, and press the TEST key on the keypad. The status line will display “TEST xxx SEC”; xxx being the remaining test time. To test an input, momentarily fault a sensor. The display will show the faulted point, its description and “1st FAULT” for the first point tested. To test another point press the TEST key, this will clear the tested sensor from the display and will refresh the test timer to its full programmed test time.

13.1 (continued)

press to  
enter test  
mode



```
STATUS TEST 600 SEC
SPEED      1000 RPM
SUCTION    102 PSIA
DISCHARGE  200 PSIG
```

Test screen is shown with no faulted points. Test key was pressed from the "RUNNING" home screen.

sensor point 24 is tested.

```
STATUS TEST 525 SEC
1st FAULT
CHAN 24
LIQUID LEVEL STAGE 1
```

press  
to test  
another  
sensor



13.2 When any of the analog channels 30-47 are tested, a "HIGH" or "LOW" indication will additionally be displayed indicating whether a high or low setpoint was tested. The display will show the current analog value for the channel selected.

A high setpoint was faulted on an analog input

```
STATUS TEST 530 SEC
1st FAULT HIGH
CHAN 33      5 PSIA
HIGH FILTER PRESS
```

13.3 If no sensors are faulted and the TEST key is pressed, the display will return to the test home screen. The test timer will be reset and speed, suction and discharge values will be displayed.

press  
test key



```
STATUS TEST 600 SEC
SPEED      1000 RPM
SUCTION    102.3 PSIA
DISCHARGE  200 PSIG
```

No sensors faulted. Test home screen is displayed.

- 13.4 To exit the test screen, press either the ESC or RESET key. Pressing the ESC key takes the user to the “STATUS RUNNING” home screen and does not reset the class B, C and output timers. Pressing the RESET key takes the user to the “STATUS TIMERS ACTIVE” home screen with the class B, C and output timers reset.

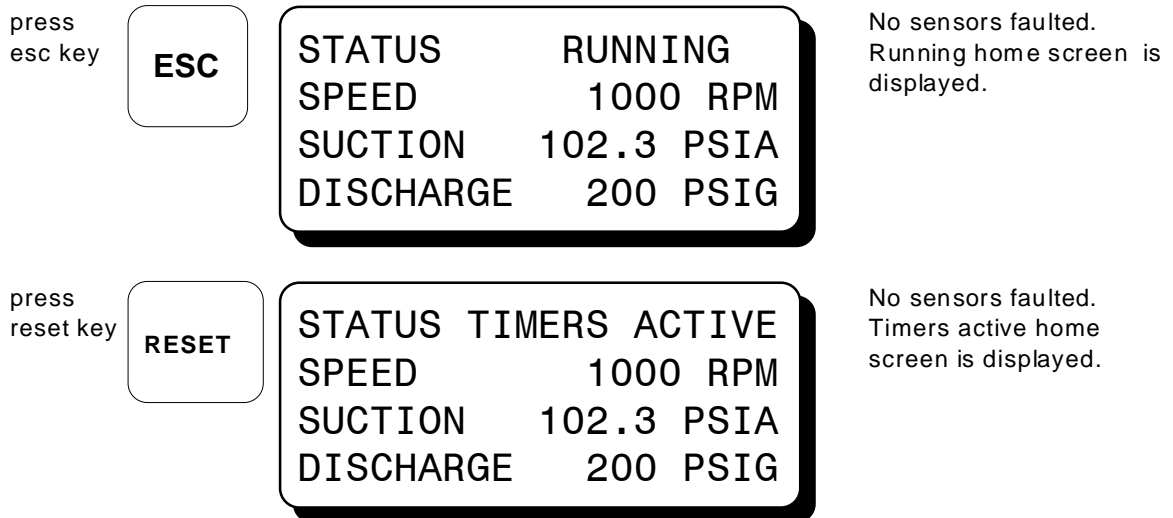

#### **14.0 VIEWING OR EDITING THE CONFIGURATION USING THE MENU MODE**

- 14.1 The menu screens can be accessed from any home screen (except test) by pressing the MENU key. The menu screens allow the user to view or edit global values, and the time and date. The controller must be initially configured using the terminal program running on a PC connected to the RS-232 port on the back of the controller. Reference the programming instructions form DE PI for instructions on how to configure the controller system for a specific application. The menu screens are intended to view or edit the already programmed values in the field. Changes made in the menu are stored in permanent memory and remain fixed until changed again. Listed below are the values that can be viewed or edited:
- A. VIEW or EDIT THE GLOBAL VALUES:
    1. TEST TIME - from 1 to 999 seconds.
    2. NODE NUMBER - from 1 to 99 (default is 1).
    3. CLASS C TIMER - from 1 to 999 minutes.
  - B. VIEW THE INPUT CLASS:
 

The input class options are:

    - Class A - no time delay on start-up.
    - Class B - 10 to 999 seconds time delay on start-up before input is active.
    - Class C - safe-until-first-met with a global time delay.
  - C. VIEW or EDIT THE OUTPUT CONFIGURATION:
    1. CONFIGURATION
      - N/O (Normally Open) - open in the normal run state and closes upon a fault
      - N/C (Normally Closed) - closed in the normal run state and opens upon a fault or loss of 12-24 Vdc input power.
      - IGN (Ignition Shorting and Fuel Valve Trip Module, Altronic P/N 691124) - open in the normal run state and closes upon a fault or loss of 12-24 Vdc.
    2. ACTIVATION DELAY TIME - from 0 to 99 seconds.
  - D. VIEW or EDIT THE TIME AND DATE:
    1. TIME or DATE

14.2 To VIEW the controller configuration from the home screen, press the MENU key. Use the NEXT key to select the group to be viewed and press ENTER. To EDIT the controller configuration, the controller system requires a password key sequence.

The password procedure is: Press the MENU key. Then press the F2 key followed by the F1 key. Upon pressing this sequence, changes can be made to the configuration.

14.3 The following keys have the same effect in all of the menu screens. If no key is pressed within one minute, the menu screen will time out and return to the current home screen.

NEXT: The NEXT key moves the selection arrow to the next selection or value without making a change to the previous value.

↑UNITS: The ↑UNITS key moves the selection arrow up one selection or increases the value by one.

↓UNITS: The ↓UNITS key moves the selection arrow down one selection or decreases the value by one.

→TENS: The →TENS key increases the value by ten.

←TENS: The ←TENS key decreases the value by ten.

ENTER: The ENTER key saves the new value and advances the selection arrow to the next value to be changed.

ESC: The ESC key returns the display back to the previous level of menu screens and when pressed again back to the current home screen.

14.4 The menu screens have two levels. The first level lists the headings of the items to be viewed or edited. Upon selecting one of the headings, the second level is displayed. Press the MENU key to enter the first level of the menu screens. The arrow points to the first selection to be viewed or edited. Three keys can be used to navigate the first level of menu selections, NEXT or ↑UNITS or ↓UNITS keys. The NEXT key will move the arrow down one selection. The ↑UNITS or ↓UNITS keys will move the selector arrow up or down one selection. Once the arrow is pointing to the selection group to be edited, press the ENTER key. The display will advance to the second level to view or allow changes to the values.

**NOTE: TO EDIT ANY VALUE, THE PASSWORD COMBINATION MUST BE ENTERED FROM FIRST LEVEL MENU. PRESS THE F2 KEY FOLLOWED BY THE F1 KEY. UPON PRESSING THIS SEQUENCE, CHANGES CAN BE MADE TO THE CONFIGURATION.**

press to enter the menu screens



first group of menu screens are shown

Use the following keys to navigate the menu screen.

to move selection arrow down



to move selection arrow down

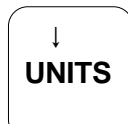

to move selection arrow up

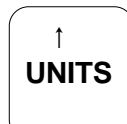

14.5 To edit the setpoint values, point to “EDIT CONTROL VALUES” and press the ENTER key. The edit control values menu is shown. The arrow points to the “EDIT SETPOINTS”.

press to  
edit set-  
points

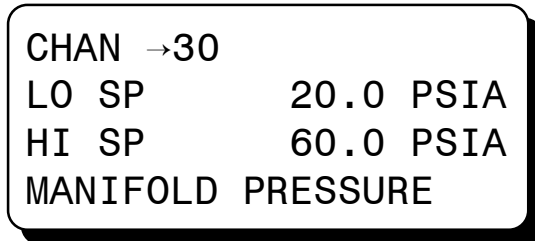
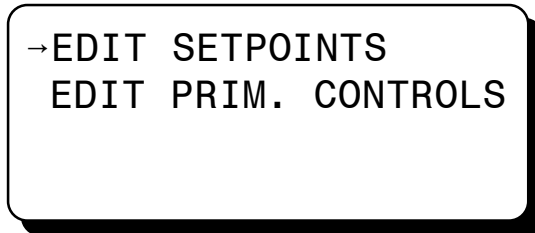

14.6 To edit Primary Controls select “EDIT CONTROL VALUES” from main menu and press the ENTER key. The edit control values menu is shown. The arrow points to the “EDIT PRIM. CONTROLS”.

press to  
edit prim.  
controls

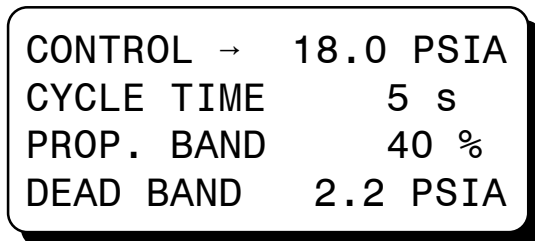
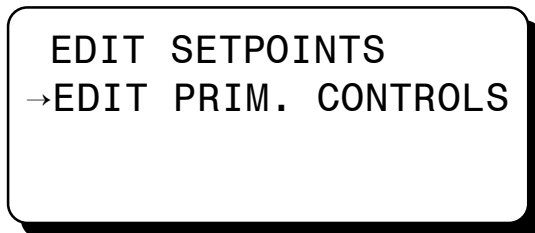

14.7 To view or edit safety shutdown values, choose “EDIT SAFETY SHUTDOWN” from the main menu. To edit or view setpoints choose “EDIT SETPOINTS”.

press to  
enter the  
menu  
screens



```
EDIT CONTROL VALUES
→EDIT SAFETY SHUTDOWN
HOURMETER FUNCTIONS
VIEW FIRMWARE REV.
```

first group of menu  
screens are shown

```
→EDIT SETPOINTS
VIEW INPUT CLASS
EDIT GLOBAL VALUES
MORE MENUS
```

```
CHAN →30
LO SP      20.0 PSIA
HI SP      60.0 PSIA
MANIFOLD PRESSURE
```

14.8 To view input class, choose “EDIT SAFETY SHUTDOWN” from main menu. Select ‘VIEW INPUT CLASS’ from next menu.

```
EDIT SETPOINTS
→VIEW INPUT CLASS
EDIT GLOBAL VALUES
MORE MENUS
```

```
CHAN →10
INPUT CLASS ♦A B C
300 SECONDS TIME
DELAY ON START-UP
```

Note: On DE-2500 units which are programmed using Terminal Software Version 2.0 and above the Sensor Class may be adjusted from the keypad. The “VIEW INPUT CLASS” display line is replaced by “EDIT INPUT CLASS”. Press NEXT key to access the Class from screen above and use RIGHT/LEFT ARROW keys to select Class A, B, C. Press ENTER to save the selection.

14.8 (continued)

Channel 10's input class configuration will be displayed. Each input channel 10-27 can be either class A, B, or C. The class for analog input channels 30-45 is programmed in the terminal program using the PC, both the high and low setpoints of these channels are individually selectable. A diamond next to the input class letter selects that class for the displayed channel.

To view channel 20's input class.

press

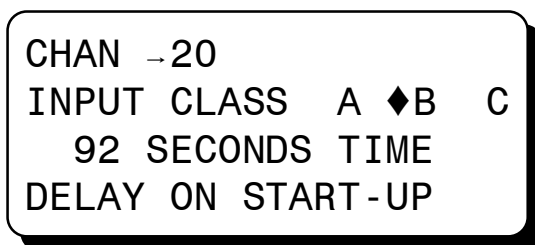
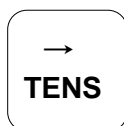

To view the next channel number, press the NEXT key until the arrow points to the channel number. Select another channel number by using the ↑UNITS or ↓UNITS keys to increase or decrease the channel by one or use the →TENS or ←TENS key to increase or decrease the channel by ten and press ENTER.

Note: On DE-2500 units which are programmed using Terminal Software Version 2.0 and above the Timer value for Class B sensors may be adjusted from the keypad. From the display shown above press the NEXT key until the arrow points to the time in seconds. Use UP/DOWN ARROW keys to select the desired time in seconds. Press ENTER to save the selection.

- 14.9 To edit global values, select "EDIT SAFETY SHUTDOWN" from main menu. Select "EDIT GLOBAL VALUES" from next menu.

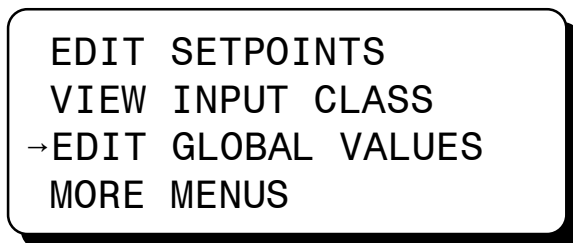

press to edit the global values

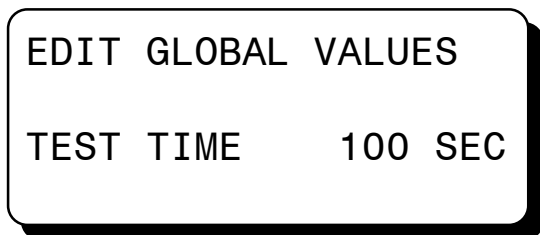

edit the class C global time

To change the global time for the class C sensor inputs, use the ↑UNITS or ↓UNITS keys to increase or decrease the value by one. Use the →TENS or ←TENS keys to increase or decrease the value by ten. Press the ENTER key to save the new value and advance to the next value to be changed. Press the NEXT key without making a change to the class C time to reach the test time. Pressing the NEXT key when the arrow is pointing to the node number brings the edit pointer back up to the class C time.

- 14.10 To edit the output configuration, choose “EDIT SAFETY SHUTDOWN” from the main menu. Select “MORE MENUS” from the following menu. Finally, select “OUTPUT CONFIG.” from the last menu.

```
EDIT SETPOINTS
VIEW INPUT CLASS
EDIT GLOBAL VALUES
→MORE MENUS
```

```
→OUTPUT CONFIG.
EDIT TIME AND DATE
COMMUNICATIONS
TO PREVIOUS MENU
```

```
OUTPUT→ 1 2
DELAY TIME 0 SEC
N/O      N/C      IGN
```

A selection arrow pointing to output 1 along with output 1’s delay time and a diamond showing whether it is configured for N/O (normally open), N/C (normally closed), or IGN (ignition output module 691124) will be shown. To view an output’s configuration, use the NEXT or →TENS or ←TENS keys to place the selection arrow in front of the output to be viewed. The output’s time delay and output state will be shown for each output.

```
OUTPUT→1 2
DELAY TIME 0 SEC
N/O      N/C      ◆IGN
```

## 14.10 (continued)

To edit an output's configuration, use the NEXT or →TENS or ←TENS keys to place the selection arrow in front of the desired output and press the ENTER key. The selection arrow will point to the delay time. Each output switch can have its own activation delay time from 0 to 999 seconds. An output switch with a delay time of 0 seconds will trip immediately upon a fault. If a delay time is set for an output switch, the output will trip following a fault plus the delay time selected. This allows, for example, a delay time between when the fuel valve trips on output 1 and when the ignition shorts on output 2.

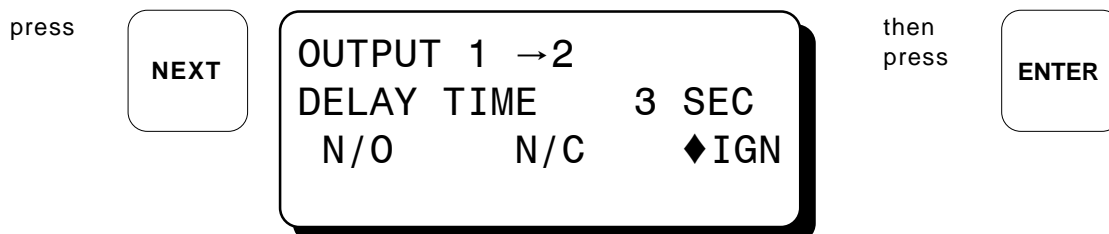

A diamond will replace the arrow in front of the selected output switch. An arrow will proceed the delay time indicating a change can be made to the selected output's delay time. Use the ↑UNITS or ↓UNITS keys to increase or decrease the value by one or use the →TENS or ←TENS key to increase or decrease the value by ten. The ENTER key accepts the change and advances the pointer to select either N/O, N/C or IGN.

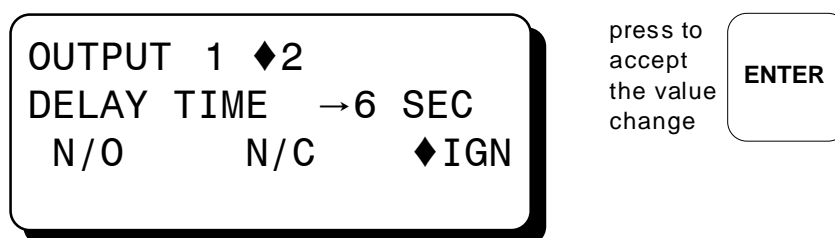

The selection arrow replaces the diamond indicating a change can be made. The selected output switch can be configured for N/O (normally open), N/C (normally closed), or IGN (ignition module 691124).

NOTE: The IGN selection is intended for the Altronic output module 691124 only. The IGN selection can be made for output switch numbers 1 and 2 only.

An output switch configured for normally open will be open in the normal run state and close upon a fault.

An output switch configured for normally closed will be closed in the normal run state and will open upon a fault or loss of 12-24 Vdc input power.

An output switch configured for the ignition module will be open during normal run and will close upon a fault or loss of 12-24 Vdc input power. Use the NEXT key to make a selection and press ENTER to save.

14.10 (continued)

press to  
select

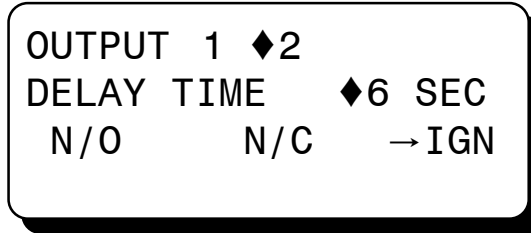

press to  
accept  
the value  
change



Upon pressing the ENTER key, a diamond will replace the selection arrow. To view or edit the next output number, press the NEXT or →TENS or ←TENS keys until the arrow points to the desired output number and repeat the process.

- 14.11 To view or edit the time and date, select "EDIT SAFETY SHUTDOWN" from the main menu. Select "MORE MENUS" from the following menu. Finally, select "EDIT TIME AND DATE" from the last menu.

from

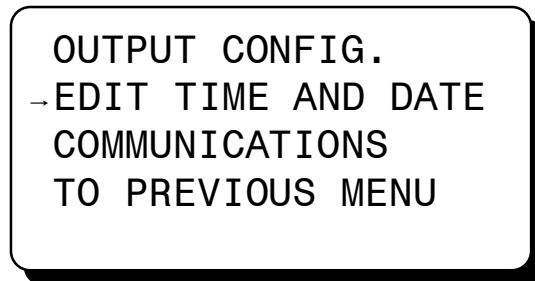

press



The time and date will be displayed with the selection arrow pointing to the time. The hours, and minutes can be edited separately, AM and PM follow the hours. With the selection arrow pointing to the hours, use the ↑UNITS or ↓UNITS keys to increase or decrease the hours. Press ENTER to save the new hour setting; the selection arrow will point to the minutes. Use the same procedure to edit the minutes. Use the NEXT key to move through the time and date screen without making a permanent change in memory.

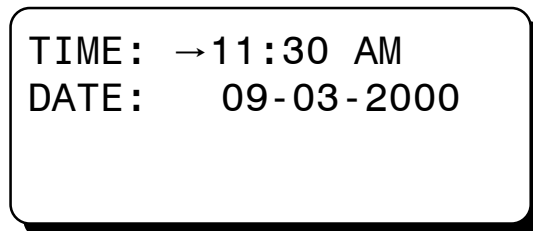

14.11 (continued)

The date is shown as month-day-year. The month, day and year can be edited separately. With the selection arrow pointing to the month, use the ↑UNITS or ↓UNITS keys to increase or decrease the month. Press ENTER to save the new month setting; the selection arrow will point to the day. Use the same procedure to edit the day and the year.

```
TIME:  11:30 AM
DATE:  →09-03-2000
```

14.12 To view or edit the communications setup, select “COMMUNICATIONS” from the menu and press ENTER.

```
COMMUNICATIONS
NODE  → 1
PORT 1  ASCII
PORT 3  MODBUS
```

Use the NEXT key to select node, port 1 or port 3; then use the UP or DOWN arrow keys to change the node number from 1 to 99 and port 1 and port 3 from ASCII to MODBUS. Press ENTER to save selection.

14.13 To view Hourmeter and Servicemeter messages, select “HOURMETER FUNCTIONS” from the main menu and press ENTER.

```
EDIT CONTROL VALUES
EDIT SAFETY SHUTDOWN
→HOURMETER FUNCTIONS
VIEW FIRMWARE REV.
```

```
HOURMETER / SERVICE
MESSAGE NUMBER: →00
TOTAL HOURS:      0
RUN TIME HOURS
```

Use the UNITS and TENS keys to view the eleven, user-programmable service messages. The F2 key can be used to reset the servicemeter timer for each individual message number.

- 14.14 To view the firmware revisions of the DISPLAY and TERMINAL modules, select "VIEW FIRMWARE REV." from the main menu then press ENTER.

```
EDIT CONTROL VALUES
EDIT SAFETY SHUTDOWN
HOURMETER FUNCTIONS
→VIEW FIRMWARE REV.
```

NOTE: Special firmware versions will display file reference number on bottom line.

```
DE - 2500
DISPLAY: 05/12/01
TERMINAL: 04/02/01
SPECIAL: 000001
```

## 15.0 VIEWING THE TIME AND DATE OF THE FIRST FAULT

- 15.1 The DE-2500 controller system "stamps" the time and date occurrence of the first fault. To view the time and date of the first fault, press the F2 key after a fault occurs but before reset is initiated. The time and date of the first fault will be displayed. If no key is pressed for 10 seconds, the display will revert back to the first fault screen. Press the ESC key to return to the current home screen.

view time  
& date of  
first fault

**F2**

```
TIME AND DATE OF
THE FIRST FAULT.
TIME: 3:10 PM
DATE: 03-25-2000
```

## **16.0 CONTRAST RATIO ADJUSTMENT**

- 16.1 The LCD contrast ratio is adjusted for optimum contrast over a large temperature range at the factory. It may be necessary however to make slight adjustments to the LCD contrast ratio because of aging and or extreme temperature changes. The contrast ratio potentiometer (TP1) is located on the back of the Display Module as shown in the drawings section. Use an adjusting tool and turn the potentiometer clockwise to lighten the contrast ratio or counterclockwise to darken the contrast ratio.

To set the potentiometer back to the factory setting: with the Display Module at an ambient temperature of approximately 65°F to 77°F (18°C to 25°C), turn the potentiometer clockwise until the display contrast ratio is almost too light to read. Turn the potentiometer counterclockwise 3 to 3-1/2 turns. The display should then be at a desirable contrast ratio.

## **17.0 DATA LOGGING AND COMMUNICATION OPTIONS**

- 17.1 The DE-2500 controller system contains a data logging feature. Data logging collects information from the system and keeps track of, or logs, that information over a period of time. That data is then available through a PC or PLC at port 1, the RS-232 port or port 3, the RS-485 port.

- 17.2 **NODE NUMBER** - The node number is the address of the controller being contacted. This number is programmed by the terminal program and can be viewed or edited in the menu screen, refer to section 14.9. A two digit number from 01 to 99 can be used.

- 17.3 **COMMUNICATIONS PARAMETERS** - The following must be set in the PC or PLC to communicate with the controller system:

Baud Rate:	9600
Data Bits:	8
Stop Bits:	1
Parity:	None

- 17.4 The data logging memory can retain a total of 100 records before writing over the oldest information. The most current data is always record number one; the next most current is number two, etc. The oldest information, record 100, is lost when a new record is written. The logging period is the time between data logs and can be set from 5 minutes to 999 minutes. The logging period must be set in the terminal program. Reference the programming instructions form DE PI to set the logging period. So for example, if the logging period is set for 60 minutes and there are 100 records, it would take 100 hours or 4.16 days before any logged data was overwritten.

A new record is also written when a first fault occurs. If the first fault occurs between the logging period, the first fault record will be record number one and the next scheduled record will be number two.

17.5 The DE-2500 system uses a simple ASCII command to read the data collected. The ASCII command must be transmitted to the controller by the PC or PLC before it can respond. The command is shown below. The hexadecimal values for the characters are shown only for those using low level (assembly language) decoding and will not appear on the communications terminal screen.

ASCII >(01 DL 001)

HEX 3Eh 28h 30h 32h 20h 44h 4Ch 20h 30h 30h 32h 29h

COMMAND HEADER ">" (3Eh) - The command must begin with the command header.

START OF TEXT "(" (28h) - The start of text character must be next.

NODE NUMBER 01 - 99 - The node number or address of the controller being contacted is next. This number is programmed by the terminal program and can be viewed or edited in the menu screen. A two digit number from 01 to 99 can be used.

SPACE (20h) - Following the node number is an ASCII space character (not printable, value 20h) to act as a delimiter between the node number and the two character command word.

COMMAND WORD "DL" (44h, 4Ch) - The command is an upper case DL for data log.

SPACE (20h) - A space again is used as a delimiter.

RECORD NUMBER 001 - 100 - The record number is the requested record. This number can be any number from 001 to 100. Record number 001 always contains the most recent record, 002 the second most recent and so on. The controller holds a maximum of 100 records in its memory before overwriting the oldest record.

END OF TEXT ")" (29h) - The end of text completes the message.

17.6 One record contains the following information:

COMP. STATION #01 GIRARD, OHIO	User entered data log header describing location
001 10333 HRS	Record number and running hours
10-19-1998 9:46 AM	Date/time the record information was collected
STATUS RUNNING	Normal home screen status line
SPEED 925 RPM	Normal home screen, line two
SUCTION 102.3 PSIA	Normal home screen, line three
DISCHARGE 300 PSIG	Normal home screen, line four
PRESS 1 102.3 PSIG	* First view process screen, line one
PRESS 2 355 PSIG	* First view process screen, line two
PRESS 3 250 PSIG	* First view process screen, line three
PRESS 4 275 PSIG	* First view process screen, line four
TEMP 1 55 °F	* Second view process screen, line one
TEMP 2 170 °F	* Second view process screen, line two
TEMP 3 180 °F	* Second view process screen, line three
TEMP 4 190 °F	* Second view process screen, line four
TEMP 5 220 °F	* 11th Analog channel value
PRESS 5 22 PSIA	* 12th Analog channel value
USER LABEL	* 13th Analog channel value
USER LABEL	* 14th Analog channel value
1ST FAULT HIGH	** First fault indication when fault occurs
CHAN A3 500 PSI	** Channel number and value of first fault
HIGH INTRSTAGE PRESS	** 20 character label associated with the first fault
10-19-1998 9:46 AM	** Date and time of the first fault

- \* If a view process screen line is not programmed in the controller, the line will be blank.
- \*\* These lines will be blank when there are no faults.

17.7 If it is desired to read more than one record, the read command can be sent in succession with a different record number. The time between read commands should be one second or longer.

17.8 The first fault data log record can be read remotely if a current fault exists in the controller. Send the following ASCII command for the first fault data log:

>(01 DL 999)

01 is the node number and should match the controller. 999 is where the current first fault is located. If this command is sent with no faults on the controller, it will respond with NO DATA AVAILABLE.

17.9 The most current data can be read remotely by sending the following ASCII command:

>(01 DL 000)

- 17.10 The value of parameters being monitored through the use of an auxiliary Altronic DSM series device can be retrieved serially through the DE-2500. This is done by sending a special serial command.

>(01 DL 00A)

The response from the DE-2500 will consist of a 512 byte ASCII text string with delimiters. The message will include the values of the monitored DSM channels as well as appropriate header information and engineering units. For this feature to be active, the auxiliary DSM option must be selected during the programming of the DE-2500.

- 17.11 The DE-2500 system can be reset or stopped remotely by sending a serial command string.  
REMOTE RESET >(01 AUTO)  
REMOTE STOP >(01 STOP)

- 17.12 The DE-2500 is compliant to the Modicon **Modbus RTU** standard. The DE-2500 only supports register reads; data is duplicated for the 30000's and 40000's address range. Maximum number of registers that can be read at one time has been limited to 32. See the Modbus Address List at pages 55-56. NOTE: The first 8 Modbus registers duplicate the registers of the Altronic DD-40NTS to simplify user software requirements, if both types of systems are in use.

- 17.13 IDENTIFICATION - In addition to the above, the DE-2500 will respond to function code 17 with an identification string as follows:

**Query:**

NN 17 CRC CRC

NN = node number, 17 = ID function code, CRC CRC = two byte Modbus RTU CRC.

**Response:**

NN 17 07 D E - 2 5 0 0 CRC CRC

NN = node number, 17 = ID function code, 07 = number of bytes to follow, DE-2500 ( seven byte ASCII ID string ), CRC CRC = two byte Modbus RTU CRC

- 17.14 REMOTE STOP/RESET - Register 40999 can be written to remotely trigger the stop and reset functions. It will respond to a single write only (function code 06). The stop command is 0x53AC. The reset command is 0x41BE.

17.15 REMOTE OPERATOR INTERFACE - The DE-2500 has a feature called the Remote Operator Interface or "ROI" that can be accessed through function code 20. This feature makes it possible for any function normally accessible locally on the keypad to be implemented remotely via Modbus. Since the response to the Key Press commands automatically returns the current display on the device, a possible conflict between local and remote control authorities can be readily avoided and the actual device status on the display is known at both locations.

**Query:**

NN 20 KP CRC CRC

Where: NN = node number, 20 = KP function code, KP is the single byte "Key Press" from the table below, CRC CRC = two byte Modbus RTU CRC.

"Key Press" Table

00 = NONE ( no keypress, returns current display )

01 = CANCEL TIMERS

02 = TEST

03 = RESET

04 = STOP

05 = VIEW

06 = NEXT

07 = UP/UNITS

08 = VIEW CHAN

09 = F1

10 = RIGHT/TENS

11 = ENTER

12 = LEFT/TENS

13 = F2

14 = MENU

15 = DOWN/UNITS

16 = ESC

**Response:**

NN 20 88 (20 bytes 1st line of display) CR LF (20 bytes 2nd line) CR LF (20 bytes 3rd line)

CR LF (20 bytes 4th line) CR LF CRC CRC

NN = node number, 20 = KP function code, 88 = number of bytes to follow,

CR = Carriage Return, LF = Linefeed, 4 20 byte ASCII blocks that is the display, CRC CRC

= two byte Modbus RTU CRC

## **18.0 AUTOMATIC CALL OUT USING AN EXTERNAL MODEM**

- 18.1 The DE-2500 controller system can perform an automatic call out upon a fault condition. When a fault occurs, the DE-2500 controller system will dial up to four preprogrammed phone numbers stored in an external modem, negotiate communications and send the first fault data log report message (the 999 command) to the Altronic monitor program on a PC or to a customer supplied device.
- 18.2 An external modem of 9600 baud or greater along with a null modem cable or adapter connected to the RS-232 port on the controller is used for remote modem communications. Please see the Altronic drawing WIRING DIAGRAM - EXTERNAL MODEM in the programming instructions form DE PI and the modems user's guide for more information on installing the modem.
- 18.3 The modem must first be configured using the monitor program to the following configuration:  
Note: The related modem configuration commands are shown in parenthesis. The commands not listed are set to factory defaults. Modem profile 0 (zero) is used by the controller system. Up to four phone numbers can be programmed in the modem.
- 9600 baud only (S37=9)
  - 8 data bits
  - 1 stop bit
  - no parity
  - DTR is always on (&D0)
  - Local Echo off (E0)
  - Display verbal result codes (V1)
  - Auto answer on the first ring (S00=1)
  - Set inactivity timer to one minute (S19=1)
  - Store the current configuration as profile 0 in nonvolatile memory (&W0)
  - Use modem profile 0 (&Y0)
  - store up to four telephone numbers in nonvolatile memory (&Zn=x)
    - n is the memory location
    - x is the phone number to be stored
- For more information on configuring the modem, please see the programming instructions. Please refer to the modem's user guide and reference manual.
- 18.4 Upon a fault, the controller sends the dial string to dial the first stored phone number in the modem (ATDTS0). If communications are established, the first fault data log report message is sent. After the first fault message is sent, a pause of about ten seconds occurs allowing for time to request other data logs. After ten seconds of no activity, the controller causes the modem to go offline. The first fault data log is then available on the remote PC for customer use. If more than one phone number is programmed in the modem, the controller will attempt to dial each number until all numbers have been successfully negotiated. If the first stored phone number in the modem is not available, the controller will immediately dial the second stored phone number. After attempting to dial all of the programmed phone numbers and if any of them were not answered, a pause of 10 minutes will occur.

After the 10 minute wait period for the line to clear, the controller will send the dial string for the unanswered stored phone numbers. This sequence will occur twenty times or until it gets a connect signal for each programmed phone number. If all faults are cleared by initiating a reset, the controller will cease dialing out.

## **19.0 TROUBLESHOOTING THE DE-2500 CONTROLLER SYSTEM**

- 19.1 The power LED's on the Power Supply and Terminal Module are blank as well as the LCD on the display module:
- A. Check the power supply voltage at the 12-24 Vdc input terminals; should be between 12 and 24 Vdc.
  - B. Check the power supply power fuse and replace if blown. NOTE: A spare fuse (part number 601653 - 6.3 amp) is provided on the power supply board.
  - C. If the Terminal Module power LED or the Display Module LCD is not on, make sure the 25-pin connectors and cable assembly are connected and secured.
- 19.2 The normally open sensors do not cause a fault:
- A. Make sure the power supply minus terminal is grounded to the panel and the panel is grounded to the engine block. They must all be at the same potential for normally open sensors that use the engine block as a return path. Use an ohmmeter and measure between the power supply minus terminal and the panel and engine block - this reading should be less than 2 ohms.
- 19.3 The output LED's are changing state but the relays or solenoid valves connected to the outputs are not tripping:
- A. Check that the wiring is correct and check the output module fuse. NOTE: A spare fuse (part number 601653 - 6.3 amp) is provided on the power supply board.
- 19.4 The power LED's are lit as well as the LCD backlighting but the LCD is blank or shows "WARNING: THE DE-2500 Controller MUST BE CONFIGURED PRIOR TO USE ON AN ENGINE":
- A. The controller system needs to be configured. See the programming instruction form DE-2500 PI to configure the system.
- 19.5 The home screen displays NO COMM. message for either the speed, suction or discharge:
- A. Communications from the terminal PCB to the DE-2500 controller have been broken. Check cable connections.
- 19.6 The home screen displays dashes for the speed, suction or discharge:
- A. A channel was not configured in the initial configuration for that parameter. See the programming instructions form DE-2500 PI to reprogram the controller system.
- 19.7 The fault screen shows that outputs one and two should be tripping the fuel valve and shorting the ignition but the fuel valve and ignition do not trip:
- A. Make sure the fuel valve and ignition shutdown lead are wired to power supply terminals FV1 and FV2 for the fuel valve and IGN+ and IGN- for the ignition shutdown lead.
  - B. Make sure that Altronic output module 691124 is in power supply output slots OUT 1 and OUT 2.
- 19.8 The time and date, after being set (refer to section 14.11 to set the time and date), are not correct after removing and reapplying the input power:
- A. The real time clock/RAM module (U10) needs replaced.
- 19.9 LCD contrast ratio on the DE-2500 Display Module is either too light or too dark:
- A. The contrast ratio needs to be adjusted. See section 16.0 CONTRAST RATIO ADJUSTMENT in these instructions.

- 19.10 The external modem does not commence dialing:
- A. A null modem cable or adapter is not used and is required from the RS-232 port to the modem.
  - B. The modem was not configured properly. Make sure that DTR is always on and that configuration 0 (zero) is being used and the phone numbers are programmed into the modem.

## **20.0 AUTO START OPTION**

- 20.1 If enabled, AUTO START is initiated by either a local contact closure at auto start terminals or by the receipt of the appropriate serial command string. AUTO START is locked out whenever an RPM greater than zero is sensed. After an aborted start attempt, the RPM must return to zero for a minimum of 5 seconds before AUTO START is re-enabled. See the sequence chart for details.

To automatically start the engine, the AUTO START option must be selected when programming the system from the PC and the starting procedure sequence defined. The first step of the AUTO START sequence is an internal reset which clears previous faults and initializes the PRE-LUBE and DELAY BEFORE CRANKING timers. The Class A safety shutdown setpoints are continuously monitored and, if faulted, will inhibit the AUTO START sequence. The Class B and Class C safety shutdown setpoints are automatically disabled by AUTO START until cranking begins. At the point of cranking, the Class B and Class C programmed setpoints start their timers and behave as if a RESET command was just received. This allows the Class B and Class C setpoints to behave in the same manner and use the same timer values for both AUTO START and MANUAL starting sequences. If a Class A setpoint should fault during an AUTO START sequence, the system will terminate the sequence and display the appropriate fault message. Initially, the auto start sequence energizes the power supply OUTPUT #4, the PRE-LUBE output. This allows for the activation of an electrically controlled pre-lube pump for a programmed time period 0 to 999 seconds prior to and/or during cranking. The use of an appropriate warning device which can be used to alert any personnel near the engine of the forthcoming start attempt is strongly recommended. This warning device (flashing lights or horn) can be activated by the PRE-LUBE output directly or thru the use of auxiliary relay contacts. After a user programmed time delay, adjustable from 0 to 999 seconds when programming the unit; the engine cranking will begin. At this time, the Class B and Class C timers will be initialized. The CRANKING motor is controlled via power supply OUTPUT #3, which would typically be used to control a solenoid valve or power relay connected to the starting device. After cranking begins, the DE-2500 system implements the engine purge cycle. The engine purge cycle consists of a 5 second roll without fuel or ignition, followed by a second 5 second delay with ignition and no fuel while still cranking. After a total purge time of ten seconds, both ignition and fuel have been enabled via outputs #1 and #2 of the power supply module and the engine should begin running. As the engine speed increases, a user programmable CRANK DISCONNECT speed switch function will automatically disable the starter at the selected RPM by de-energizing OUTPUT #3. If the crank disconnect RPM is not reached within a user programmed time period after the cranking output is energized (15 to 99 seconds), an OVERCRANK FAULT will be generated. The OVERCRANK FAULT will turn off the fuel and ignition and disable the starter until a new AUTO START command is received. After the engine has started and the cranking device is turned off, the 4-20 ma. RPM control output to the governor will ramp to the IDLE speed value. The RPM control output will stay at the IDLE value until a user programmed delay set by the WARM-UP TIMER is completed. After the WARM-UP period, the RPM CONTROL OUTPUT will ramp to MINIMUM LOAD RPM current. After the governor responds and the MINIMUM LOAD RPM is reached, automatic control of the compressor loading by the DE-2500 will begin.

## SEQUENCE CHART FOR AUTO START:

**EVENT OR COMMAND** [---FAULT or STOP---][ AUTO START]

**ENGINE STATUS** [-----STOPPED-----][---WAITING---][--CRANKING--][--RUNNING--]

**OUTPUTS**

**IGNITION OUT #1** [---OFF-----][5 sec][-----ON-----]

**FUEL OUT #2** [---OFF-----][5 sec][--ON-----]

**PRE-LUBE OUT #4** [---OFF-----][-----ON---timer 0-999 sec-----][--OFF--]

**CRANKING OUT #3** [---OFF-----][--ON--rpm/timer][--OFF----]

**RPM OUT 4-20 ma** [-----ZERO-SPEED-----][--IDLE--]

**CAPACITY 4-20 ma** [-----UNLOADED-----]

**LOAD PULSE OUT UNLOAD** [-----OFF-----]

[-----ON--MAX--PULSE-WIDTH--ONCE--PER--LOOP-----]

**INPUTS**

**CLASS A** [-----ARMED-----]

**CLASS B** [---TIMERS---][--ARMED-----]

**CLASS C** [---ARMED AS CLEARED-----]

**NOTES:** AUTO START IS INHIBITED BY SENSING ANY RPM ABOVE 0 RPM. AUTO START IS ABORTED BY THE DETECTION OF ANY MONITORED FAULT. CLASS B AND CLASS C TIMERS BEGIN AT CRANKING. A LOCAL WARNING SIGNAL AT THE ENGINE SITE PRIOR TO CRANKING SHOULD BE PROVIDED.

## **21.0 AUTOMATIC COMPRESSOR LOAD CONTROL**

21.1 The DE-2500 control system is designed to control the throughput or gas transmission rate of engine or motor driven compressors. The throughput or actual volume of gas compressed by the machine per unit of time can be controlled by two different means. The two means are: A) to vary the rate at which compression events occur, SPEED CONTROL or B) to vary the volume of gas compressed per event, CAPACITY CONTROL. For both reciprocating and screw compressors, the most efficient type of throughput control is to change the repetition rate of the compressor action, that is the cycles per unit time or SPEED CONTROL. This parameter is normally described in terms of the operating RPM of the prime mover. The control of the prime mover speed to change the compressor throughput is almost 100% efficient with respect to the work required by the compressor itself for the increased throughput. For a given set of operating conditions; suction pressure, discharge pressure, gas temperature and gas composition; the effort required to move each cubic foot of gas (a fixed mass) remains constant. Each stroke of the reciprocating compressor or each turn of the screw compressor (unless modified physically) captures the same amount of gas at the input end (suction). Each compressor cycle moves the same mass of gas to the output end (discharge). This action requires the same torque for each cycle from the prime mover. As the rate (prime mover RPM) of compressor events (each requiring a fixed amount of Torque) is increased, so is the horsepower (RPM X TORQUE). At the same time, the volume of gas compressed is increasing at the same rate. In this case, the horsepower and the throughput increase together in direct proportion with very little lost work. This is why SPEED CONTROL is generally the first step in managing compressor throughput.

A factor which limits the effectiveness of speed control in compressor throughput management, is the RPM range of the prime mover available with adequate torque. In the case of gas engines in particular, the prime mover efficiency is significantly affected by the operating RPM. Most gas engines, for example, can carry their rated torque load with acceptable performance in only the upper 1/2 or 1/3 of their rated RPM range. For this reason, it is necessary to select a MINIMUM RPM and a MAXIMUM RPM to define the range in which the DE-2500 will control the speed of an engine/ compressor system. After a startup sequence MANUAL or AUTO START, the speed of the prime mover must reach the MINIMUM LOAD RPM for load control to begin. After the MINIMUM LOAD RPM is reached, the CAPACITY CONTROL OUTPUT will be used to begin increasing compressor throughput per cycle using CAPACITY CONTROL to satisfy the PRIMARY CONTROL setpoint. In a screw compressor application the amount of gas moved per turn of the screw (work per cycle) is typically controlled by using a slide or turn valve (internal stepless bypass). In reciprocating compressor applications an external bypass is often used. For more detail on applications see section 22. The PRIMARY CONTROL input parameter is selected during the programming of the unit as either CHANNEL 30, 31, or 32. The input value of the assigned parameter (30,31,32) is compared to the setpoint and the CAPACITY OUTPUT varied to maintain this value within a user selected DEADBAND in a closed loop fashion, at a rate determined by user adjustable tuning values. In a typical application, channel 30 would be engine intake manifold pressure, channel 31 would be compressor suction pressure, and channel 32 would be compressor discharge pressure. The DE-2500 system will continue to increase the CAPACITY OUTPUT to its maximum value in an attempt to reach the PRIMARY CONTROL setpoint. If the PRIMARY CONTROL setpoint is not reached by the time that the CAPACITY CONTROL has reached 100%, then the DE-2500 controller will begin to increase the RPM CONTROL OUTPUT to the governor.

21.1 (continued)

The governor input (4-20 ma from the DE-2500 ) will be automatically adjusted within the user programmed MINIMUM RPM to MAXIMUM RPM range to satisfy the PRIMARY CONTROL setpoint.

Restating the section above, once the CAPACITY CONTROL OUTPUT reaches 100% the DE-2500 system will attempt to satisfy the PRIMARY CONTROL setpoint with the CAPACITY OUTPUT held at its maximum value (100%) by adjusting the RPM. When controlling the speed, the DE-2500 will automatically adjust the engine speed by means of the governor setpoint to any value between the MINIMUM RPM and the MAXIMUM RPM set by the user when programming the unit. When conditions change in a manner which requires a reduction in compressor throughput, the DE-2500 will first reduce the speed. The speed will be reduced to the MINIMUM RPM value before the CAPACITY CONTROL OUTPUT will be changed. That is, if the PRIMARY CONTROL setpoint cannot be satisfied by running at the MINIMUM RPM and 100 % CAPACITY ( compressor throughput still too high), then the DE-2500 will begin reducing the CAPACITY OUTPUT to reach the setpoint. The basic control is made to function in this manner since RPM CONTROL of compressor throughput is the most efficient for both screw and reciprocating type machines, but both RPM and CAPACITY CONTROL are often needed to cover a wider range of compressor throughput requirements.

**COMPRESSOR LOAD CONTROL SEQUENCE :**

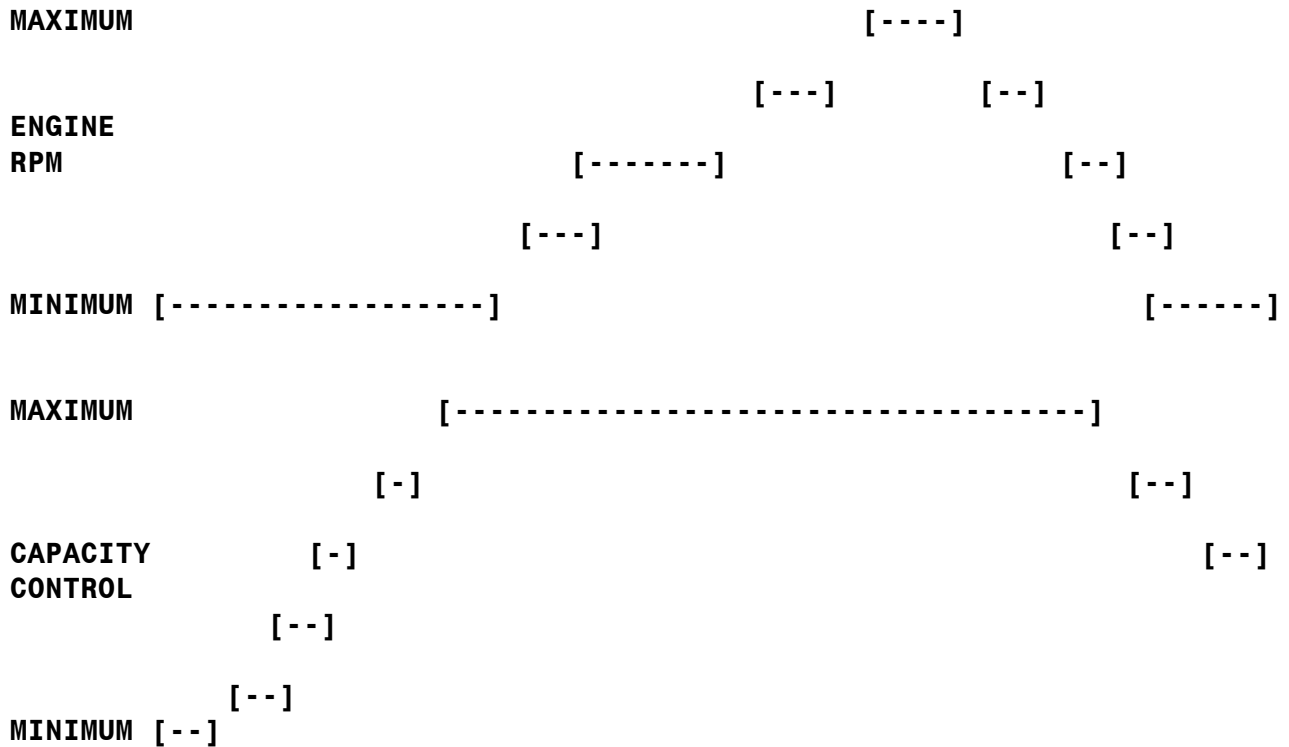

## **22.0 SELECTING A CONTROL STRATEGY**

- 22.1 The control strategy best suited to a particular application varies widely. The following information is offered as a set of general guidelines and definitions. Each application should be evaluated by qualified personnel familiar with the actual operating conditions.
- 22.2 The DE-2500 controller is normally programmed to regulate compressor throughput by controlling both speed and capacity. In any particular application, it may be desirable to control the compressor using only one of these. This can be done on an intermittent basis using the MANUAL override options for speed or capacity control from the keypad to disable the selected function. If it is desired to permanently disable either speed or capacity control, this can be done when programming the unit. To use capacity control only, for example, the prime mover normally runs at a fixed RPM, then the control values for the MINIMUM RPM and the MAXIMUM RPM are simply programmed as the same value. If the compressor has no means of bypassing or regulating gas flow to control capacity and only speed control can be used, then the capacity outputs are left unconnected and the DE-2500 will regulate only the engine RPM.
- 22.3 The speed control output of the DE-2500 is a 4-20 ma current loop which can be connected directly to an electronic governor. The RPM values corresponding to 4 ma and 20 ma for the governor are entered during the programming of the DE-2500 so that the control output is prescaled to the correct value for the minimum and maximum RPM setpoints. If a governor requiring a pneumatic setpoint (3-15 psi ) is used then the 4-20 ma output is connected to an appropriate I/P transducer.
- 22.4 The capacity control output of the DE-2500 is available in two formats, to drive the most common actuating systems. The first output format is an industry standard 4-20 ma current loop. The 4-20 ma output would be used to interface to pneumatically controlled turn valves on screw compressors (internal stepless bypass) or to pneumatically controlled external bypass valves on reciprocating compressors. In both of these cases, the 4-20 ma output is connected to an appropriate I/P transducer which then connects via tubing to the actuator. See drawing. The second set of capacity control outputs is brought out of the controller in a digital format (discrete transistors). The digital or discrete outputs consist of two transistors which switch on to ground and are designed to drive relay coils or pilot duty solenoid valves. One switch is labeled DIGITAL OUT 1 and energizes to LOAD the compressor the other is labeled DIGITAL OUT 2 and energizes to UNLOAD the compressor. When used with the hydraulically positioned slide valve on a screw compressor application, these outputs are typically connected to a three-way solenoid valve. On reciprocating compressors, the digital outputs can be used to actuate a motor controlled bypass valve via relay contacts which energize the motor in the open or close directions.

- 22.5 The PRIMARY control input should be selected on the basis of the prevailing operating conditions at the compressor site as well as considerations of loading fluctuations ,etc. Some basic approaches to compressor load control are listed below :

Suction pressure control - By holding suction pressure at a nearly constant value, a large number of limited flow rate wells can be kept productive with minimal upset conditions. Usually this approach is characterized as a relatively limited supply, or a low flow rate supply of gas, at a given site. This approach may also be required as part of various reclamation or vapor recovery programs.

Discharge pressure control - By holding discharge pressure at a constant value, a trunk line feeding a larger compressor, or pipeline system, permits a supply of gas to be delivered at a rate approximately equal to the rate at which it is to be consumed. The amount of gas being compressed is not necessarily limited by its availability at the compressor site, but by how much has been consumed by the destination site.

Engine Manifold pressure control - By adjusting the compressor throughput on the basis of engine manifold pressure, compressed gas is being produced at a rate that is determined by the horsepower available at the site. This approach would be used where there is plenty of gas available at the wellhead and all of it that is produced can be sold or consumed. In this situation, the only limitation on compressor loading is how much work the engine can do without subjecting it or the compressor to an overload. In the case of electric motor driven compressors, a motor current sensor or kW sensor works in the same manner as the engine manifold pressure sensor on a gas engine.

- 22.6 When programming the DE-2500 system the basic relationship of the PRIMARY CONTROL INPUT, PRIMARY CONTROL OUTPUT and OUTPUT ACTUATOR need to be defined.

The relationship between the PRIMARY CONTROL INPUT and PRIMARY CONTROL OUTPUT is defined as to be either DIRECT or INVERSE acting. DIRECT acting means that to increase the value of the PRIMARY CONTROL INPUT the throughput of the compressor is increased. INVERSE acting means that to increase the value of the PRIMARY CONTROL INPUT the compressor load must be decreased. In the examples of common control approaches given; discharge pressure and engine manifold pressure or motor amps are direct acting. Suction pressure is an example of a control parameter that is inverse acting. In order to increase suction pressure the compressor throughput must be reduced.

In addition to defining the input/output relationship, the relationship of the control output value to the actuator must also be defined as either direct or inverse acting. As in the case of the control input/output relationship, the direct acting output mechanism is one where an increase in current from the controller causes an increase in load on the compressor. An inverse operating actuator is one where the current is decreased to increase the load on the compressor.

22.7 The DE-2500 controls the compressor throughput based upon the PRIMARY control input; an analog value selected from channels 30, 31, or 32 which would typically be engine manifold pressure, suction pressure or discharge pressure respectively. Additionally, the DE-2500 controller allows for up to 14 additional SECONDARY CONTROL setpoints for compressor throughput control or other supplemental control functions.

For each of the 14 analog inputs and engine RPM, both a low and a high CONTROL setpoint is provided. These CONTROL setpoints are in addition to the safety shutdown setpoints. The violation of a CONTROL setpoint (below a low or above a high setpoint value) causes a SECONDARY CONTROL action to occur. The SECONDARY CONTROL actions which can be programmed using Terminal Software version 1.8 or lower are shown below. For units being programmed from Terminal software 2.0 or higher see section 22.8.

- A) INHIBIT LOADING OF PRIMARY CONTROL
- B) FORCE UNLOADING OF PRIMARY CONTROL
- C) ACTIVATE SECONDARY CONTROL OUTPUTS

For the 13 analog input parameters NOT assigned to the PRIMARY CONTROL FUNCTION, the control setpoints can be individually assigned to INHIBIT LOADING or FORCE UNLOADING. When the INHIBIT LOADING selection is made, any violation of the setpoint value will automatically prevent any additional loading of the compressor, regardless of the status of the PRIMARY control loop. One typical application of the LOAD INHIBIT function for a secondary control setpoint would be a permissive to load signal based upon the temperature of the oil being used for oil injection on a screw compressor. By assigning a LOAD INHIBIT function to the oil temperature low control setpoint, the screw compressor will not be loaded until the oil has reached the required minimum temperature.

Because each of the monitored analog channels has these two control setpoints available, many fairly elaborate control options are possible. For example, the DE-2500 system can be configured in a manner to take advantage of varying ambient operating conditions. An example of this would be to limit the compressor throughput of a reciprocating compressor on the basis of a high discharge gas temperature. In some cases, the compressor gas cooling system is not capable of maintaining an acceptable discharge temperature at the highest compressor throughput of the machine on the hottest days. This same cooling system can maintain an acceptable discharge temperature at maximum throughput during normal weather conditions. By setting a load inhibit function on high discharge temperature, which is somewhat higher than normal at maximum throughput on cooler days, but well below the safety shutdown setpoint, the primary control setpoint can be selected to take advantage of the cooler weather by running at maximum throughput whenever possible. The secondary control LOAD INHIBIT function permits this without the risk of overheating the compressor on the hottest days without requiring a change to the PRIMARY CONTROL setpoint based on the weather.

The FORCE UNLOADING function can be used in conjunction with the LOAD INHIBIT or independently. When a control setpoint which has been assigned the FORCE UNLOAD function is violated, the throughput of the compressor will be reduced. When conditions return to normal, the programmed control routine will resume. This function is intended to prevent the transient overloading of compressor, or engine components, by forcing the unloading of the system before the conditions can cause equipment damage or equipment shutdown due to the safety shutdown setpoints being violated.

## 22.7 (continued)

In addition to the capability to assign each of the setpoints (2 per channel) and the LOAD INHIBIT and FORCE UNLOAD functions, there are 6 auxiliary control outputs which can be used to implement corrective actions, sound alarms, etc. These outputs are rated for 60 VDC and 2 amp maximum. These outputs would typically be connected to solenoid valves or control relays. The control outputs are transistors which turn on to system ground when a control setpoint assigned to them is violated. The assignment of the auxiliary output channels is non-exclusive. That is to say that multiple channels can be assigned to a single output or multiple outputs to a single channel in whatever combination is desired. In the first example above of a low injection oil temperature control setpoint on a screw compressor being used to inhibit loading, an auxiliary control output (#3 for example) could also be assigned to this setpoint which would energize a heater to increase the oil temperature to allow loading. In the second example of limited compressor throughput due to cooling capacity, an auxiliary output (#4 for example) assigned to the high discharge temperature setpoint could be used to turn on a fin-fan to increase cooling or activate a solenoid valve allowing for an optional coolant routing through an additional heat exchanger. The control setpoints are active at all times, even if the engine is not running. This allows for protective or corrective actions controlled by these outputs to be implemented prior to attempting a startup. The potential applications of the secondary control setpoints are too numerous to compile here.

## 22.8 On DE-2500 units programmed using Terminal Program 2.0 or higher, the control setpoint options have been modified to add more flexibility as detailed below.

Inhibit an output increase - The output of one or more of the control loops can be limited in the increasing direction only, while allowing the assigned output to freely decrease.

Inhibit an output decrease - The output of one or more of the control loops can be limited in the decreasing direction only, while allowing the assigned output to freely increase.

Force an output increase - The output of one or more of the control loops can be forced to increase even if the primary control loop requires a different action.

Force an output decrease - The output of one or more of the control loops can be forced to decrease even if the primary control loop requires a different action.

In addition to these actions being assignable to the analog inputs, they are also assignable to the analog outputs. This allows for the output of one control loop to interact with the other according to a programmed priority. For example, the output of loop #2 can be inhibited until a certain output value of Loop #1 is reached.

## **23.0 CALIBRATION OF TRANSDUCERS**

Connect the computer cable from the computer to the DB9 port #1 on the back of DE-2500 display module.

Using the DE-2500 software resident on the CDROM, open the DE-2500 program. Then click on the "CALIBRATE" button at the top of the screen.

Select the number of channel to be calibrated.

The sensor selection box will show either the default value or the past calibrated value depending the firmware version of the DE-2500.

Under the "CALIBRATION SETPOINT" section you will find a box that reads "CURRENT DATA". This is the actual information being displayed on the DE-2500 Display.

On the Terminal Board connect a voltmeter between the (+) and (-) transducer output terminals for the channel being calibrated.

Apply the desired minimum pressure or temperature to the transducer being calibrated. Next take note of the voltage being measured on the voltmeter, this voltage is to be entered in the "LOW SENSOR VOLTAGE" box. Then click the "ACCEPT" key to enter the new low value.

Increase the pressure or temperature to the desired high reading of the transducer being calibrated. Again take note of the voltage being measured and enter the measured voltage in the "HIGH SENSOR VOLTAGE" box and hit accept.

Your calibration of that channel is complete.

## **GLOSSARY:**

ACTUATOR	Electromagnetic devices which convert electric current to linear or rotary motion. This motion may then be used to control equipment directly, an electro-mechanical actuator, or it can be used to regulate a gas or liquid pressure as in a CURRENT TO PRESSURE converter (I/P).
ANALOG INPUT	An input which accepts voltage signals between 0 and 5 volts. These signals are converted by the DE-2500 to engineering units and compared by the microprocessor to user programmed safety shutdown and control setpoints. Channels 30-37 and 40-45 are analog inputs.
ANALOG OUTPUT	An output which provides a current between 4-20 milliamps to external devices to control the compressor. These outputs can be used to interface directly to electrical actuators or connected to I/P transducers mechanical actuators.
CAPACITY CONTROL	The capacity control of the compressor is accomplished by reducing the volume of gas moved per compressor cycle. 100% capacity is the full rated volume of gas compressed per machine cycle. Capacity control can be done on both reciprocating and screw compressors using various techniques.
COMPRESSOR CYCLE	A compressor cycle is a full rotation of the compressor drive shaft. A turn of the screw on a screw compressor or a revolution of the crankshaft on a reciprocating compressor.
CONTROL SETPOINTS	These are setpoints programmed by the user which are within the normal operating range of the equipment and are used to optimize the function of the equipment. Control setpoints may also be used to implement corrective actions to prevent overstress of components or to notify personnel of potential problems before they become severe enough to cause a shutdown.
CRANK DISCONNECT	The RPM setting at which output # 3 of the power supply will be de-energized. This will de-energize the starting device.
CRANKING DELAY	The time after the auto start command before cranking will begin. Allows for pre-lube function and starting warning to personnel. Power supply output # 4 is normally energized during this time. See PRE-LUBE TIME.

**GLOSSARY (continued):**

CURRENT STEP LIMIT	The current step limit is a maximum value that the analog output will be allowed to change from one control cycle to another. The current step limit is used to prevent rapid or erratic control action of the actuator even under transient conditions or with a poorly tuned control system. A limit of about 2 ma or about 10 % of the output range is reasonable default value.
CYCLE TIME	The time taken between adjustments of the PRIMARY CONTROL loop. The longer the cycle time selected the less responsive the control output is to variations in the controlled parameter. The cycle time is adjustable from 1 to 999 seconds.
DEADBAND	The controller deadband defines a user programmed value both above and below the setpoint for which no corrective action will be taken. Deadband is used to improve control stability by holding the controller output constant in the presence of “noise” or small transient errors on the input.
DIRECT ACTING	When describing control or actuator functions, direct acting is used to identify relationships where the controller must increase its output to cause an increase in the variable.
INVERSE ACTING	When describing control or actuator functions, inverse acting is used to identify relationships where the controller must decrease its output to cause an increase in the variable.
MAXIMUM RPM	The maximum RPM setting is the highest governor setpoint value which will be sent by the controller in an attempt to satisfy the primary control setpoint. The maximum running RPM.
MINIMUM RPM	The minimum RPM is the governor setpoint value which will be sent by the controller after the warmup delay time has been fulfilled. The minimum RPM is the speed which must be seen by the controller to allow loading of the compressor to begin.
OVERCRANK TIME	The maximum time that the starting device will remain energized by output # 3 before the starting attempt is considered failed. If an overcrank occurs, the crank disconnect RPM is not reached before the overcrank time, then an overcrank fault has occurred.
PRE-LUBE TIME	A user programmed time for which output # 4 will remain ON after the beginning of an AUTO START sequence. Normally used for control of a pre-lube pump and to signal that a starting attempt is about to begin.
PRIMARY CONTROL	The primary control is a closed loop based upon an input value selected from channels 30, 31, or 32. The throughput of the compressor is adjusted by the controller to maintain this setpoint.

**GLOSSARY (continued):**

PROPORTIONAL BAND	The proportional band is used to tune the response of the controller to the characteristic behavior of the equipment being controlled. Proportional band is the inverse of gain expressed as a percentage. A proportional band setting of 10% is equal to a gain setting 10, a proportional band setting of 20% is equal to a gain of 5, etc. The smaller the proportional band setting the greater the controller response to a difference between the measured value and the setpoint.
RPM CHANGE / CYCLE	The maximum RPM change per cycle is used to limit the rate at which the controller output to the governor will be allowed to change. This limit is used to avoid rapid speed changes during transient conditions.
SAFETY SHUTDOWN	Safety shutdown setpoints are those which cause the protected equipment to be shutdown or stopped in order to protect the equipment and or the operating personnel. These setpoints must be selected to be outside the range of normal operation.
SECONDARY CONTROL	Secondary or supplemental control functions are accomplished by sensing user programmed control setpoints. LOAD INHIBIT or FORCE UNLOAD strategies, as well as alarms or corrective actions can be implemented.
THROUGHPUT	The total volume of gas per unit of time moved by the compressor. Throughput is varied by both speed and capacity adjustments made by the controller.
WARMUP DELAY	The warmup delay time is user programmable from 0 to 99 minutes. This allows for the engine/compressor to run unloaded for this time delay as part of the auto start sequence. The engine speed output to the governor will be held at the idle RPM value during the warmup delay.

## MODBUS ADDRESS LIST:

ADDRESS	DESCRIPTION OF FUNCTION	RANGE
40001	RPM	0 to 9999
40002	Hours	0 to 65535
40003	Reserved	0 at all times
40004	Status, 00=start up, 01=running, 60=stop, xx=fault no.	00 to 60
40005	Output status 1-4=bits 0-3 in order, 0=fault, 1=inactive	0 to 16
40006	Inputs 10-17=bits 0-7, 20-27= bits 8-15, 0=faulted	0 to 65535
40007	Inputs 30-37=bits 0-7, 40-46=bits 8-14, 0=faulted, bit 15=1	32768 to 65535
40008	Reserved	65535 at all times
40009	Chan. 30-46 faults, bit 0=1 Lo setpoint bit 1=1 Hi setpoint	0 to 2
40010	From this register to 40049 reserved for future use	0 to 65535
40050	Optional DSM Chan. 1 analog value	-9999 to 9999
40051	Optional DSM Chan. 2 analog value	-9999 to 9999
40052	Optional DSM Chan. 3 analog value	-9999 to 9999
40053	Optional DSM Chan. 4 analog value	-9999 to 9999
40054	Optional DSM Chan. 5 analog value	-9999 to 9999
40055	Optional DSM Chan. 6 analog value	-9999 to 9999
40056	Optional DSM Chan. 7 analog value	-9999 to 9999
40057	Optional DSM Chan. 8 analog value	-9999 to 9999
40058	Optional DSM Chan. 9 analog value	-9999 to 9999
40059	Optional DSM Chan. 10 analog value	-9999 to 9999
40060	Optional DSM Chan. 11 analog value	-9999 to 9999
40061	Optional DSM Chan. 12 analog value	-9999 to 9999
40062	Optional DSM Chan. 13 analog value	-9999 to 9999
40063	Optional DSM Chan. 14 analog value	-9999 to 9999
40064	Optional DSM Chan. 15 analog value	-9999 to 9999
40065	Optional DSM Chan. 16 analog value	-9999 to 9999
40066	Optional DSM Chan. 17 analog value	-9999 to 9999
40067	Optional DSM Chan. 18 analog value	-9999 to 9999
40068	Optional DSM Chan. 19 analog value	-9999 to 9999
40069	Optional DSM Chan. 20 analog value	-9999 to 9999
40070	Optional DSM Chan. 21 analog value	-9999 to 9999
40071	Optional DSM Chan. 22 analog value	-9999 to 9999
40072	Optional DSM Chan. 23 analog value	-9999 to 9999
40075	Optional DSM Chan. 1 decimal point position from right	0 to 3
40076	Optional DSM Chan. 2 decimal point position from right	0 to 3
40077	Optional DSM Chan. 3 decimal point position from right	0 to 3
40078	Optional DSM Chan. 4 decimal point position from right	0 to 3
40079	Optional DSM Chan. 5 decimal point position from right	0 to 3
40080	Optional DSM Chan. 6 decimal point position from right	0 to 3
40081	Optional DSM Chan. 7 decimal point position from right	0 to 3
40082	Optional DSM Chan. 8 decimal point position from right	0 to 3
40083	Optional DSM Chan. 9 decimal point position from right	0 to 3
40084	Optional DSM Chan. 10 decimal point position from right	0 to 3

**MODBUS ADDRESS LIST (continued):**

ADDRESS	DESCRIPTION OF FUNCTION	RANGE
40085	Optional DSM Chan. 11 decimal point position from right	0 to 3
40086	Optional DSM Chan. 12 decimal point position from right	0 to 3
40087	Optional DSM Chan. 13 decimal point position from right	0 to 3
40088	Optional DSM Chan. 14 decimal point position from right	0 to 3
40089	Optional DSM Chan. 15 decimal point position from right	0 to 3
40090	Optional DSM Chan. 16 decimal point position from right	0 to 3
40091	Optional DSM Chan. 17 decimal point position from right	0 to 3
40092	Optional DSM Chan. 18 decimal point position from right	0 to 3
40093	Optional DSM Chan. 19 decimal point position from right	0 to 3
40094	Optional DSM Chan. 20 decimal point position from right	0 to 3
40095	Optional DSM Chan. 21 decimal point position from right	0 to 3
40096	Optional DSM Chan. 22 decimal point position from right	0 to 3
40097	Optional DSM Chan. 23 decimal point position from right	0 to 3
40100	Analog value Chan. 30	-9999 to 9999
40101	Analog value Chan. 31	-9999 to 9999
40102	Analog value Chan. 32	-9999 to 9999
40103	Analog value Chan. 33	-9999 to 9999
40104	Analog value Chan. 34	-9999 to 9999
40105	Analog value Chan. 35	-9999 to 9999
40106	Analog value Chan. 36	-9999 to 9999
40107	Analog value Chan. 37	-9999 to 9999
40108	Analog value Chan. 40	-9999 to 9999
40109	Analog value Chan. 41	-9999 to 9999
40110	Analog value Chan. 42	-9999 to 9999
40111	Analog value Chan. 43	-9999 to 9999
40112	Analog value Chan. 44	-9999 to 9999
40113	Analog value Chan. 45	-9999 to 9999
40114	Analog value Chan. 46	-9999 to 9999
40115	Chan. 30 decimal point position from right	0 to 3
40116	Chan. 31 decimal point position from right	0 to 3
40117	Chan. 32 decimal point position from right	0 to 3
40118	Chan. 33 decimal point position from right	0 to 3
40119	Chan. 34 decimal point position from right	0 to 3
40120	Chan. 35 decimal point position from right	0 to 3
40121	Chan. 36 decimal point position from right	0 to 3
40122	Chan. 37 decimal point position from right	0 to 3
40123	Chan. 40 decimal point position from right	0 to 3
40124	Chan. 41 decimal point position from right	0 to 3
40125	Chan. 42 decimal point position from right	0 to 3
40126	Chan. 43 decimal point position from right	0 to 3
40127	Chan. 44 decimal point position from right	0 to 3
40128	Chan. 45 decimal point position from right	0 to 3

## **INDEX BY SECTION:**

- 1.0 OVERVIEW
- 2.0 DISPLAY MODULE
- 3.0 POWER SUPPLY MODULE
- 4.0 TERMINAL MODULE
- 5.0 MOUNTING
- 6.0 WIRING
- 7.0 HAZARDOUS AREA OPERATION
- 8.0 KEYPAD DESCRIPTION
- 9.0 UNDERSTANDING THE HOME SCREENS
- 10.0 VIEW PROCESS INFORMATION SCREENS
- 11.0 VIEW CHANNEL STATUS SCREENS
- 12.0 SHUTDOWN OF FAULT STATUS SCREENS
- 13.0 TEST MODE SCREENS
- 14.0 VIEWING OR EDITING CONFIGURATION
- 15.0 VIEWING THE TIME AND DATE OF FIRST FAULT
- 16.0 CONTRAST RATIO ADJUSTMENT
- 17.0 DATA LOGGING AND COMMUNICATION OPTIONS
- 18.0 AUTOMATIC CALL OUT USING AN EXTERNAL MODEM
- 19.0 TROUBLESHOOTING
- 20.0 AUTO START OPTION
- 21.0 AUTOMATIC COMPRESSOR LOAD CONTROL
- 22.0 SELECTING A CONTROL STRATEGY
- 23.0 TRANSDUCER CALIBRATION

**DRAWINGS SECTION:**

DE-2500 SYSTEM DIAGRAM

DE-2500 CONTROLLER, MOUNTING DIMENSIONS AND SPECIFICATIONS

DE-2500 TERMINAL MODULE AND POWER SUPPLY MODULE

WIRING DIAGRAM - GENERAL HOOK-UP

WIRING DIAGRAM - PERSONAL COMPUTER

WIRING DIAGRAM - RS-485 COMMUNICATION

WIRING DIAGRAM - POWER SUPPLY MODULE

WIRING DIAGRAM - SENSOR AND TRANSDUCER INPUTS

WIRING DIAGRAM - CURRENT LOOP OUTPUTS

WIRING DIAGRAM - DIGITAL OUTPUT SWITCHES

POWER SUPPLY LED AND OUTPUT MODULE LOCATIONS

CONTRAST ADJUSTMENT AND MEMORY LOCATION

# DE-2500 SERIES SYSTEM DIAGRAM

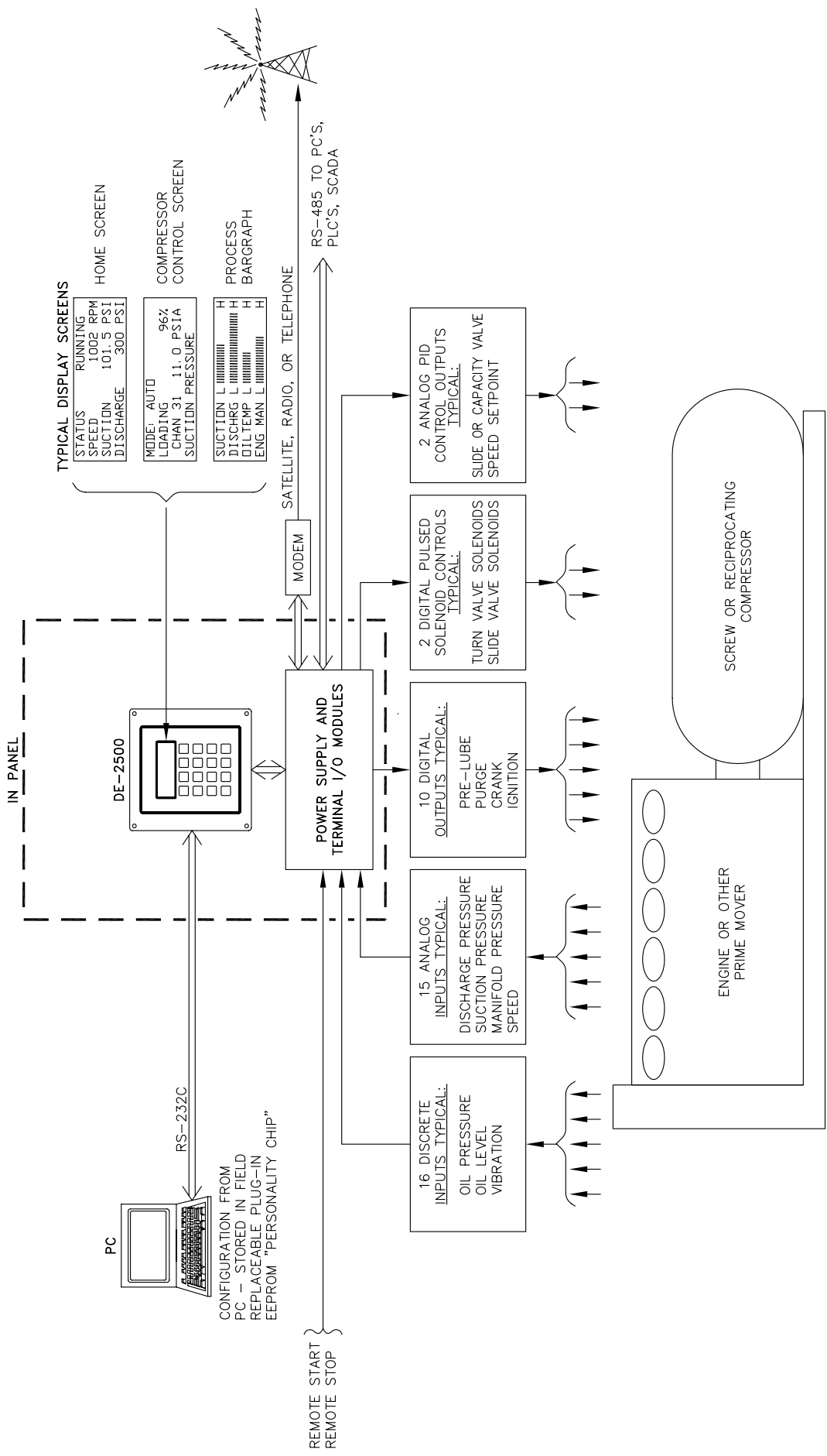

# DE-2500 CONTROLLER

## MOUNTING DIMENSIONS AND SPECIFICATIONS

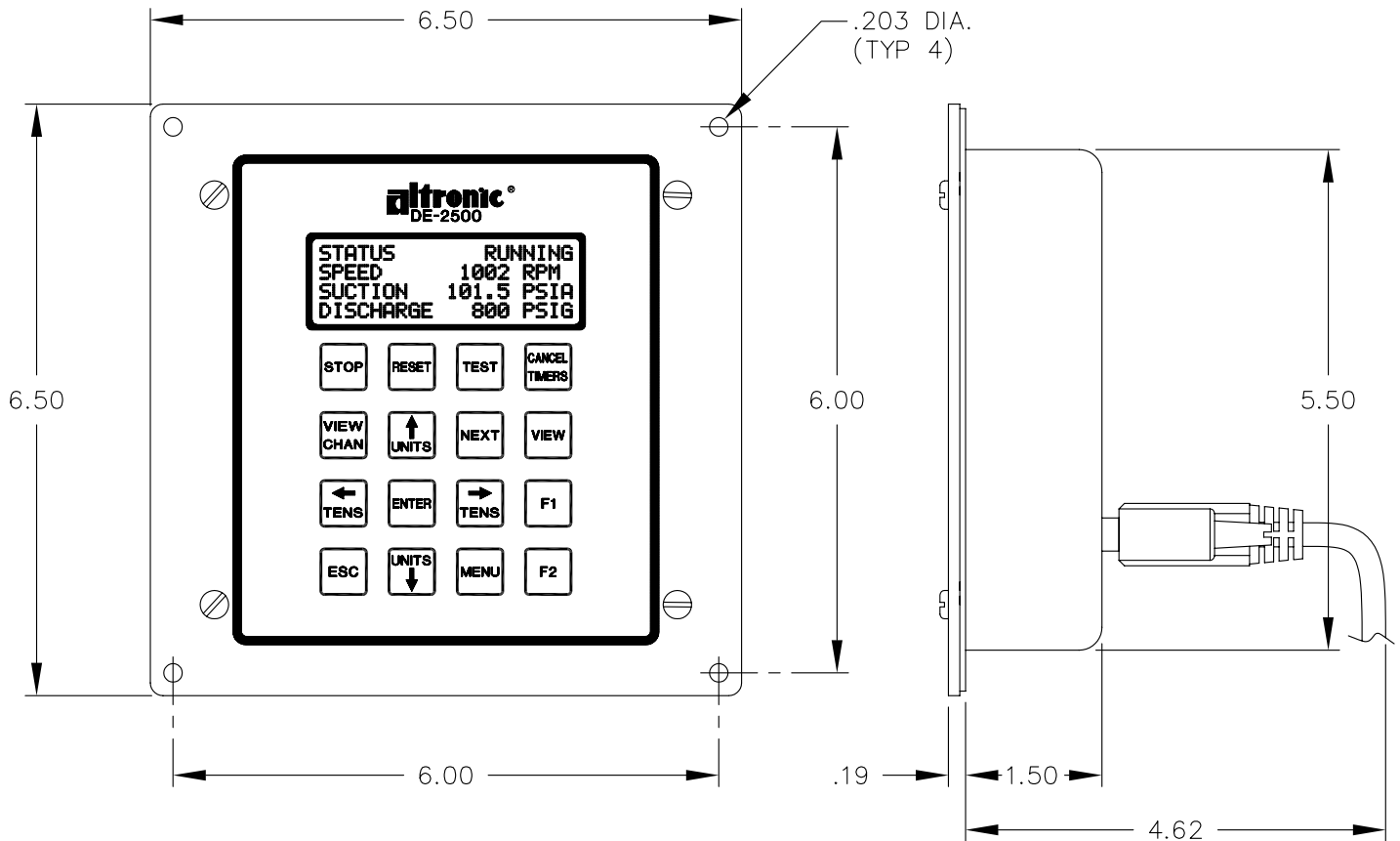

### SPECIFICATIONS:

POWER REQUIRED: DC POWERED 12-24 VDC, 10 WATTS TYPICAL 15 WATTS MAXIMUM.

INPUTS: 16 DISCRETE SWITCH INPUTS EITHER NORMALLY OPEN OR NORMALLY CLOSED.  
REMOTE RESET AND REMOTE STOP.

14 ANALOG INPUTS 0-5 VOLTS FOR COMPRESSOR CONTROL AND MONITORING.

RPM INPUT: .5 - 361 PPR

OUTPUTS: UP TO FOUR STANDARD DIGITAL OUTPUT MODULES OR AN ALTRONIC IGNITION SHUTDOWN AND FUEL VALVE TRIP OUTPUT MODULE (691124) AND TWO STANDARD DIGITAL MODULES FOR ENGINE CONTROL.

UP TO 8 DEDICATED DIGITAL OUTPUTS FOR COMPRESSOR CONTROL.

2 AUXILIARY 4-20mA OUTPUTS.

DISPLAY: 4 X 20 LCD CHARACTER DISPLAY WITH LED BACKLIGHT.

TIME KEEPING: REAL TIME CLOCK AND CALENDAR WITH BATTERY BACKUP.

SCAN RATE: SCANS ALL DISCRETE SWITCHES PLUS REMOTE RESET AND STOP 15 TIMES/SECOND.

OPERATING TEMPERATURE RANGE: -35°C TO +80°C (-31°F TO 176°F).

COMMUNICATIONS: 2 EACH RS-485, CONNECTION ON POWER SUPPLY.  
1 EACH RS-232, CONNECTION ON DISPLAY MODULE.

HAZARDOUS AREA CLASSIFICATION: CLASS 1, GROUP C, D, DIV. 2, T4.





# WIRING DIAGRAM – PERSONAL COMPUTER

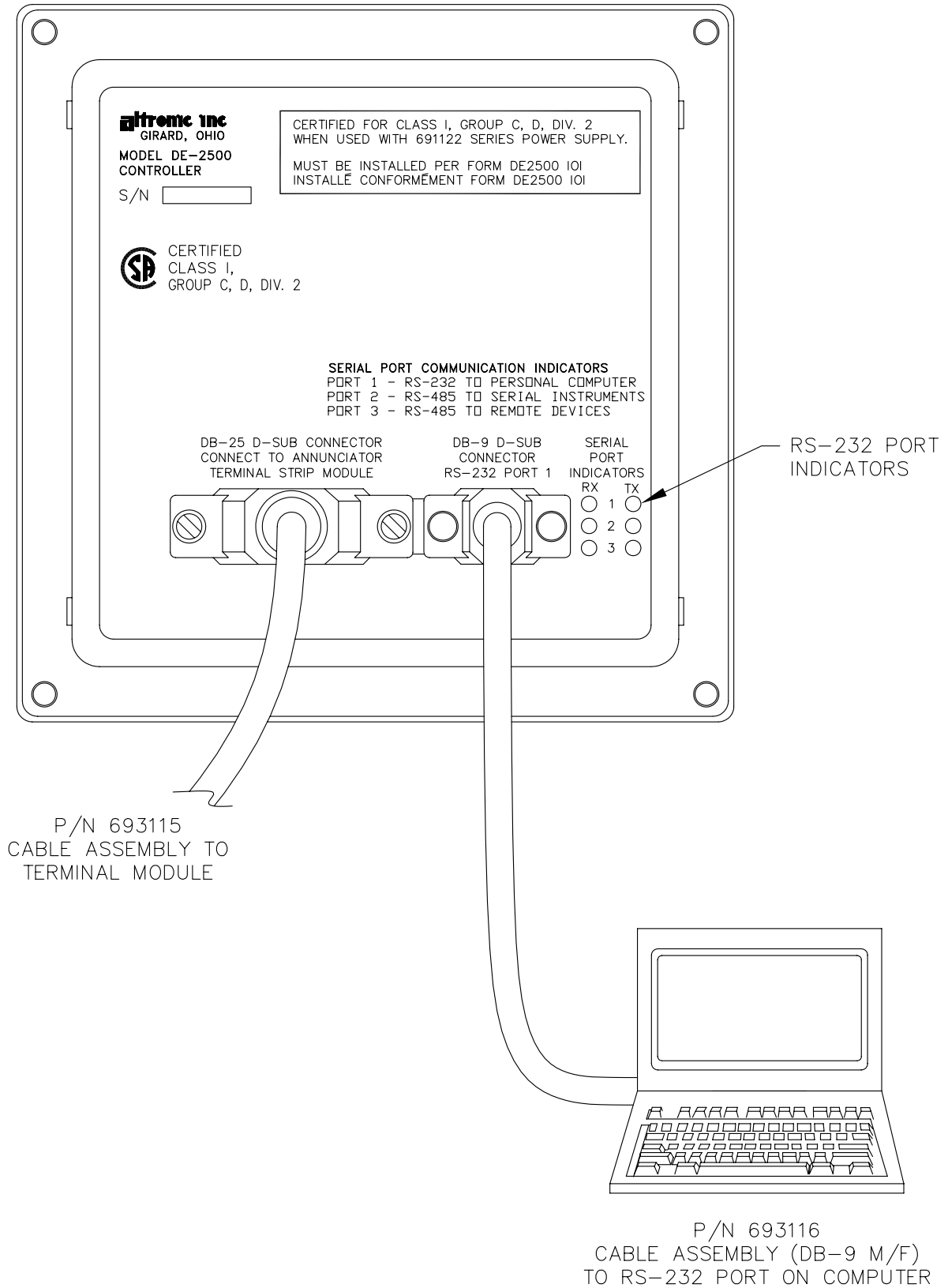

# WIRING DIAGRAM – RS-485 COMMUNICATIONS

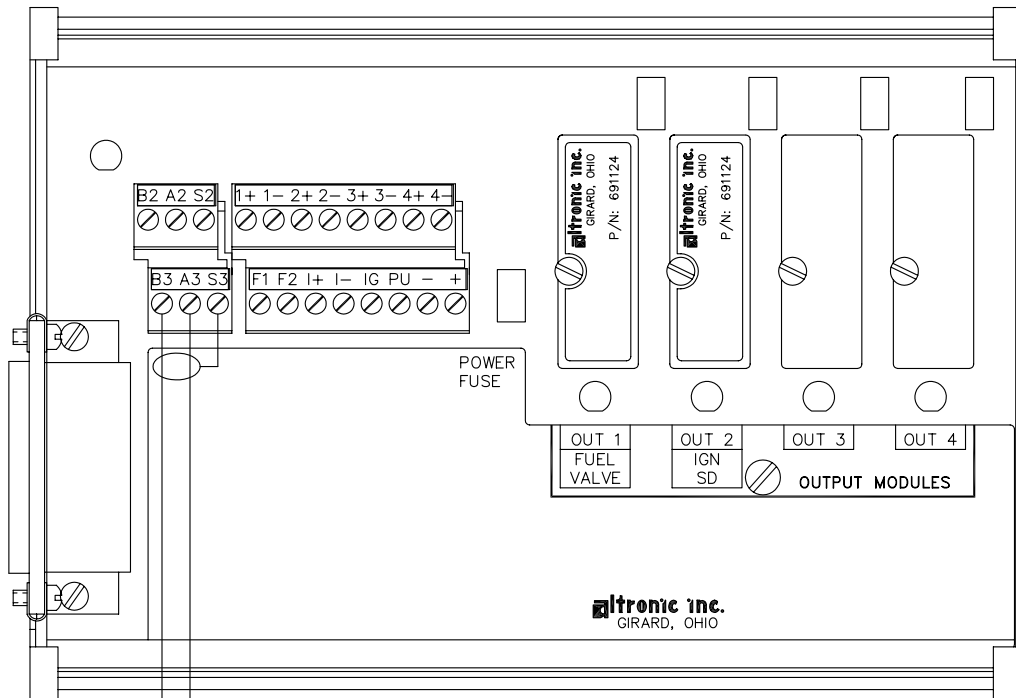

PC or PLC

RS-485 "A"  
RS-485 "B"

NOTE: CONNECT A 120Ω RESISTOR BETWEEN RS-485 "A" AND RS-485 "B" TERMINALS AT THE POWER SUPPLY MODULE FOR WIRE RUNS GREATER THAN 500 FEET TOTAL.

## NOTES:

1. USE SHIELDED CABLE FOR RS-485 CONNECTIONS. CONNECT SHIELD AT POWER SUPPLY MODULE ONLY.
2. EACH PLC MUST HAVE A UNIQUE NODE NUMBER. MAXIMUM 32 NODES.
3. TO MINIMIZE UNWANTED REFLECTIONS ON THE RS-485 LINE, THE WIRES SHOULD BE HOOKED-UP FROM ONE INSTRUMENT TO THE NEXT IN A DAISYCHAIN FORMAT.

# WIRING DIAGRAM – POWER SUPPLY MODULE

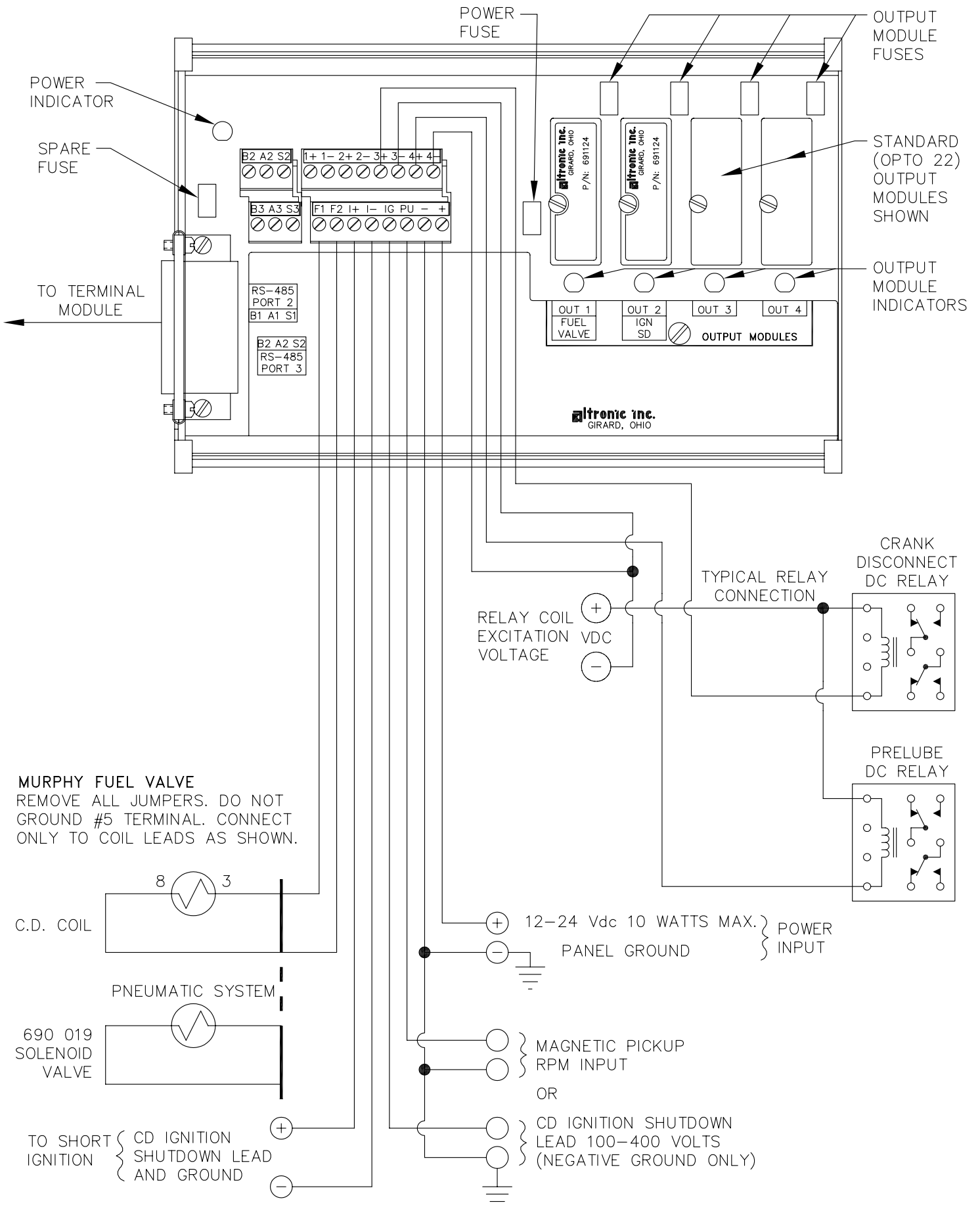

# WIRING DIAGRAM – SENSOR AND TRANSDUCER INPUTS

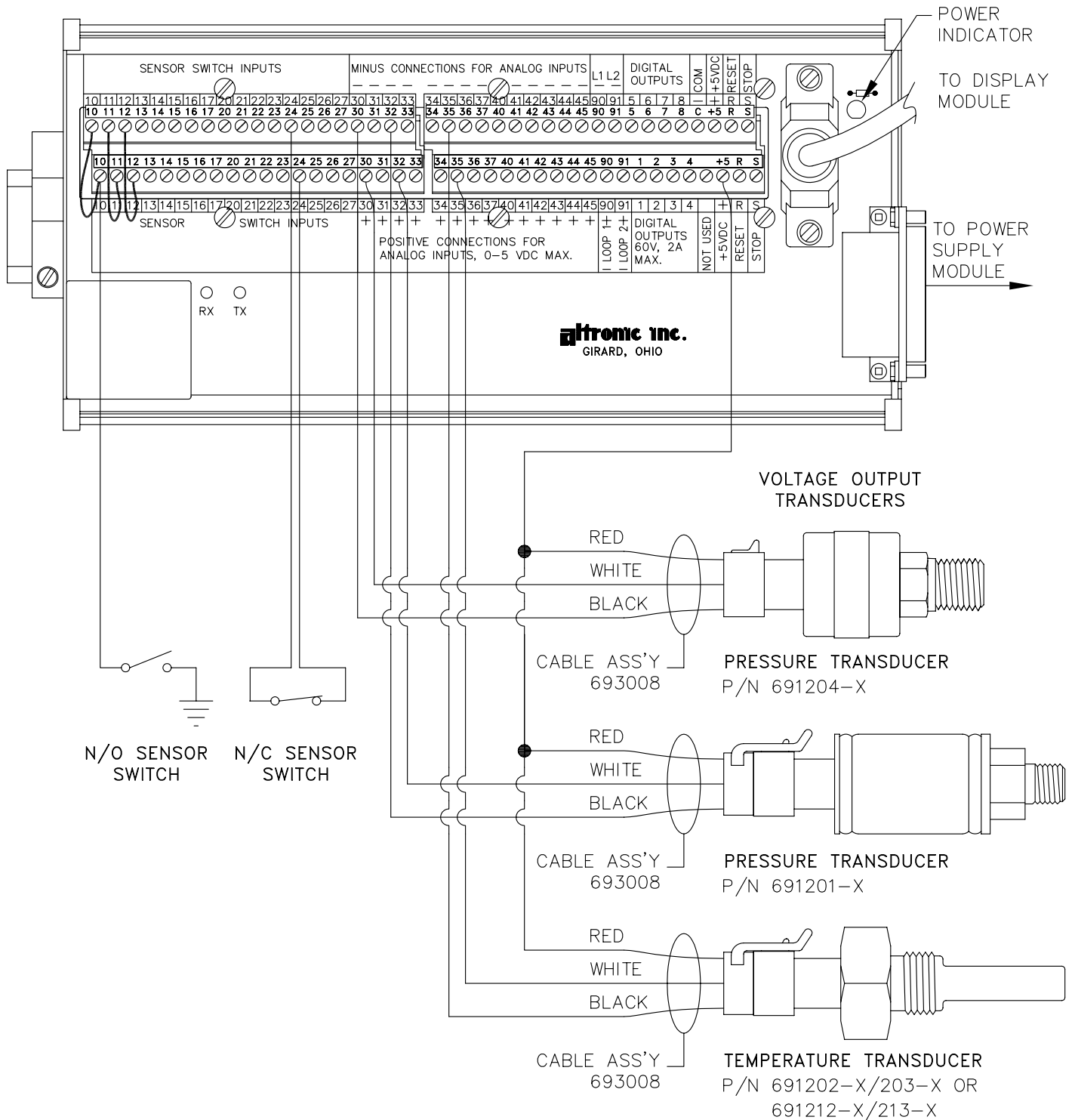

- NOTE: 1. N/O SENSOR SWITCH MUST HAVE JUMPER IN PLACE BETWEEN TOP ROW AND BOTTOM ROW OF TERMINAL BLOCK. POWER SUPPLY MINUS AND SENSOR GROUND MUST BOTH BE AT GROUND.
2. N/C SENSOR SWITCH, REMOVE JUMPER AND PLACE SWITCH WIRES, ONE IN TOP ROW OTHER IN BOTTOM ROW.
3. ALL UNUSED INPUTS MUST HAVE JUMPER WIRE IN PLACE.
4. REMOTE RESET (R) AND REMOTE STOP (S) ARE WIRED SAME AS OTHER SWITCHES. STOP OVERRIDES RESET.
5. THE +5VDC INTERNAL SUPPLY OUTPUT IS LIMITED TO 500 mA MAXIMUM. IF THIS SUPPLY EXITS THE PANEL, IT MUST BE FUSED WITH A 0.5 AMPERE FUSE. BOTH +5VDC TERMINALS ARE ELECTRICALLY CONNECTED TOGETHER. TWO TERMINALS ARE PROVIDED FOR WIRING CONVENIENCE ONLY.

# WIRING DIAGRAM – CURRENT LOOP OUTPUTS

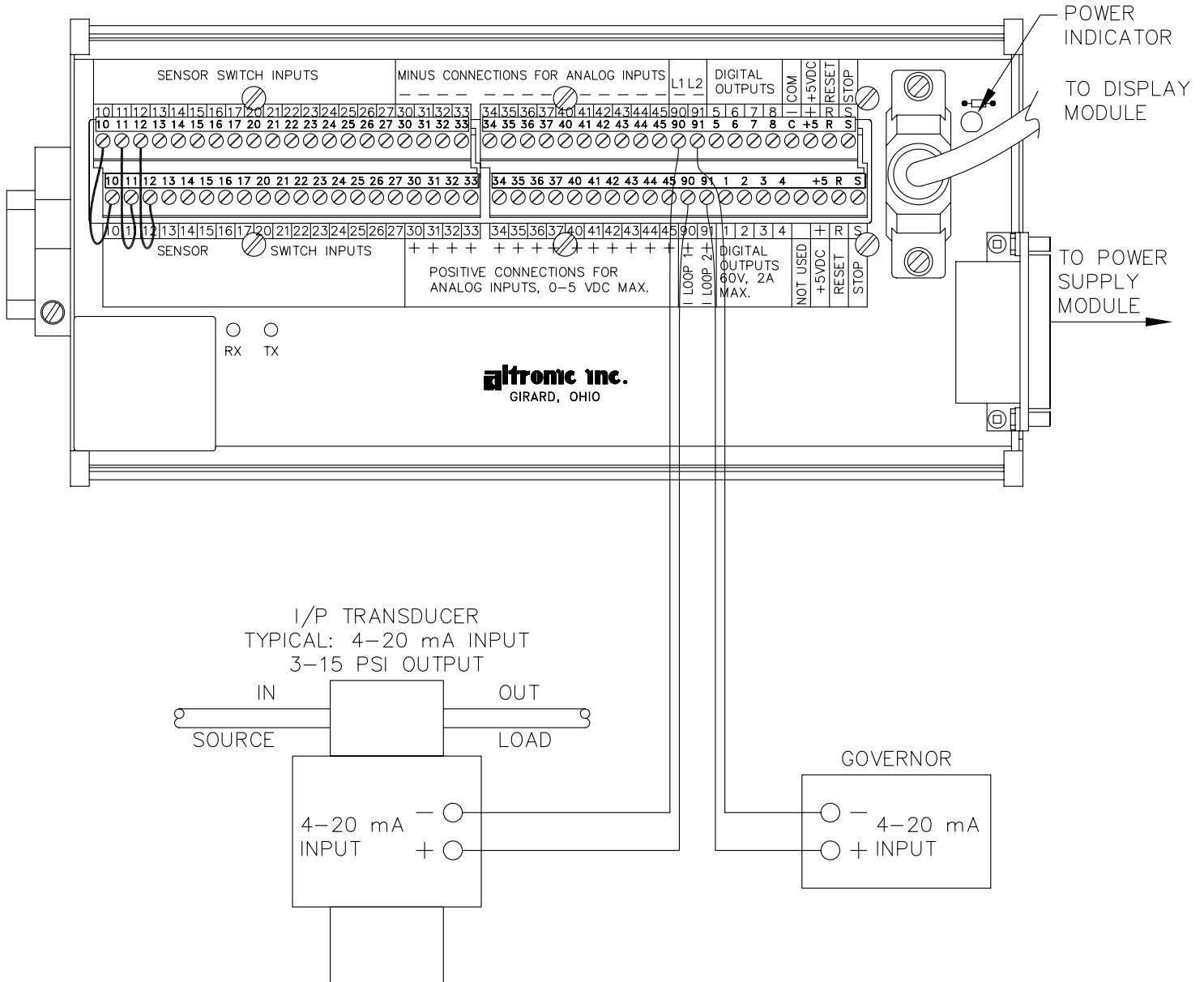

## NOTES:

1. CURRENT LOOP OUTPUT 1 IS TYPICALLY USED TO CONTROL CAPACITY CONTROL. CURRENT LOOP OUTPUT 2 IS TYPICALLY USED AS A GOVERNOR SPEED SETPOINT FOR SPEED CONTROL.
2. FOLLOW MANUFACTURERS RECOMMENDATIONS FOR MOUNTING AND MECHANICAL HOOK-UP OF CURRENT LOOP CONVERTERS.

# WIRING DIAGRAM – DIGITAL OUTPUT SWITCHES

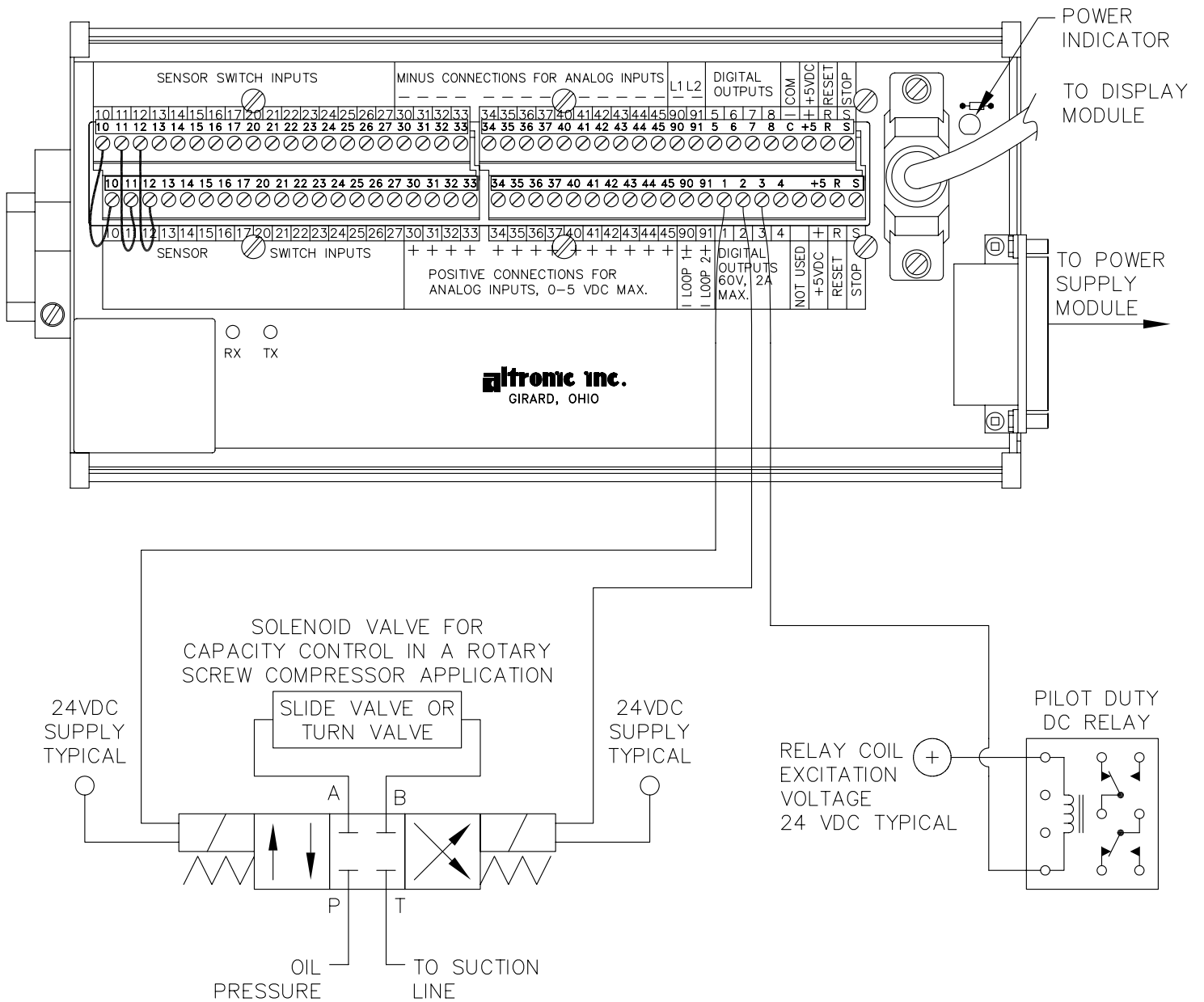

## NOTES:

1. SOLENOID VALVE: 4 WAY SOLENOID CLOSED-CENTER TYPE. BOTH PORTS BLOCKED IN CENTER POSITION WITH BOTH SOLENOIDS DE-ENERGIZED.
2. DIGITAL OUTPUT 1 ENERGIZED TO LOAD, DIGITAL OUTPUT 2 ENERGIZED TO UNLOAD.
3. THIS DIAGRAM SHOWS TYPICAL CONNECTIONS. FOLLOW MANUFACTURERS RECOMMENDATIONS FOR COMPLETE SYSTEM COMPONENTS AND HOOK-UP.
4. USE PILOT DUTY RELAYS CONNECTED TO DIGITAL OUTPUTS TO CONTROL.
  - OIL OR WATER COOLERS
  - OIL TEMPERATURE CONTROL VALVE
  - OIL HEATERS
  - PRELUBE PUMPS AND OTHER AUXILIARY EQUIPMENT

# POWER SUPPLY LED AND OUTPUT MODULE LOCATIONS

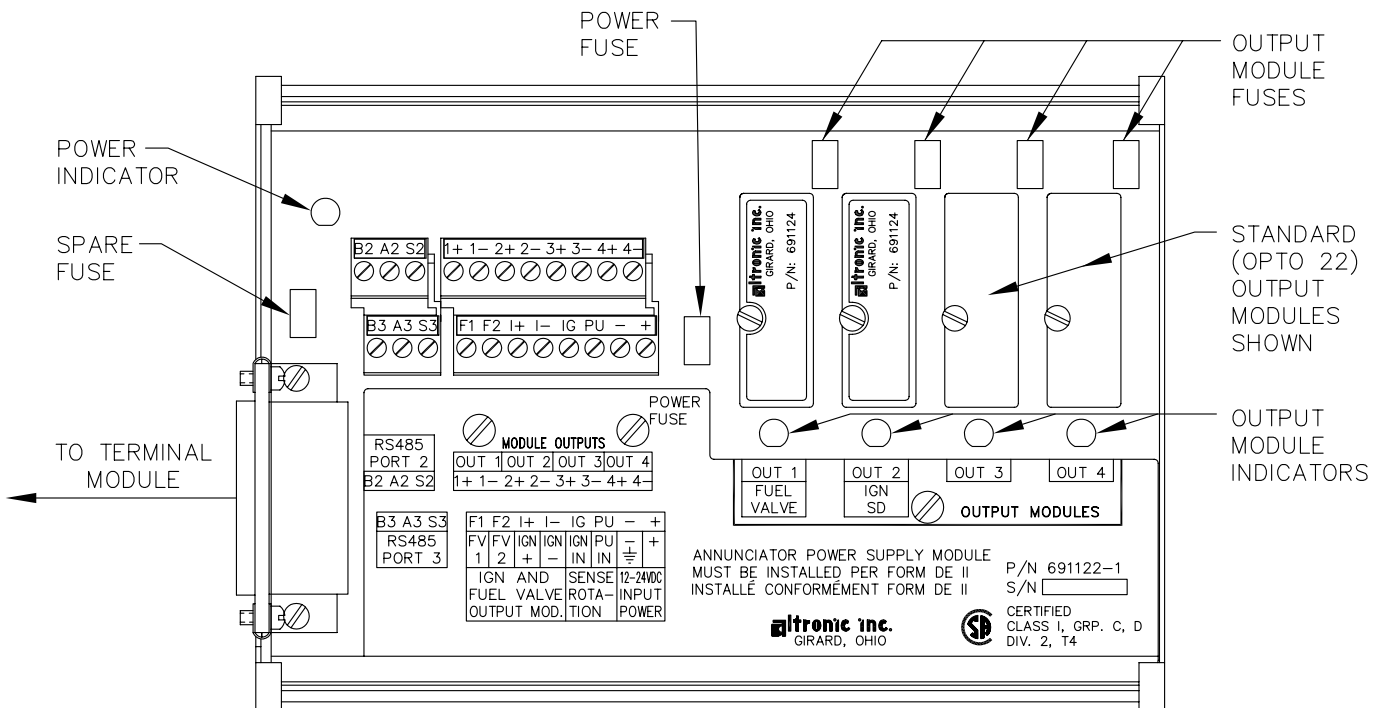

**FUSES:** FUSES ARE REPLACEABLE 6.3 AMP, P/N 601653.

**OUTPUT MODULES:** 691124 – THIS CUSTOM MODULE HAS TWO USES: CONNECTION TO A MURPHY FUEL VALVE AND DIRECTLY GROUNDING A C.D. IGNITION SYSTEM.

- USE IN POSITION OUT 1 TO CONNECT TO A C.D. IGNITION TYPE MURPHY FUEL VALVE.
- USE IN POSITION OUT 2 TO DIRECTLY GROUND–OUT (STOP) A C.D. IGNITION SYSTEM.

691125 – THIS STANDARD MODULE IS RATED FOR 5–48 Vdc, 5.0 A. AND MAY BE USED IN ANY OF THE FOUR OUTPUT SLOTS OUT 1 THROUGH OUT 4.

691056 – THIS STANDARD MODULE IS RATED FOR 5–60 Vdc, 2.0 A. AND MAY BE USED IN ANY OF THE FOUR OUTPUT SLOTS OUT 1 THROUGH OUT 4.

691066 – THIS STANDARD MODULE IS RATED FOR 5–200 Vdc, 0.67 A. AND MAY BE USED IN ANY OF THE FOUR OUTPUT SLOTS OUT 1 THROUGH OUT 4.

691065 – THIS STANDARD MODULE IS RATED FOR 24–280 Vac, 2.0 A. AND MAY BE USED IN ANY OF THE FOUR OUTPUT SLOTS OUT 1 THROUGH OUT 4.

**NOTE:** OTHER INDUSTRY STANDARD 0.6 INCH MODULES MAY BE USED AS REQUIRED.

**LED OPERATION:** – THE POWER LED INDICATOR LIGHTS WHEN POWER IS APPLIED TO THE SYSTEM.

- FOR THE NORMALLY CLOSED CONFIGURED OUTPUT MODULES (ENERGIZED FOR RUN), THE LED WILL BE ON IN THE NORMAL RUN STATE AND OFF FOR A FAULT CONDITION.
- FOR THE NORMALLY OPEN CONFIGURED OUTPUT MODULES, THE LED WILL BE OFF IN THE NORMAL RUN STATE AND TURN ON FOR A FAULT CONDITION.
- FOR THE ALTRONIC OUTPUT MODULES P/N 691124, THE LED WILL BE ON IN THE NORMAL RUN STATE AND OFF FOR A FAULT CONDITION.

# CONTRAST ADJUSTMENT AND MEMORY LOCATION

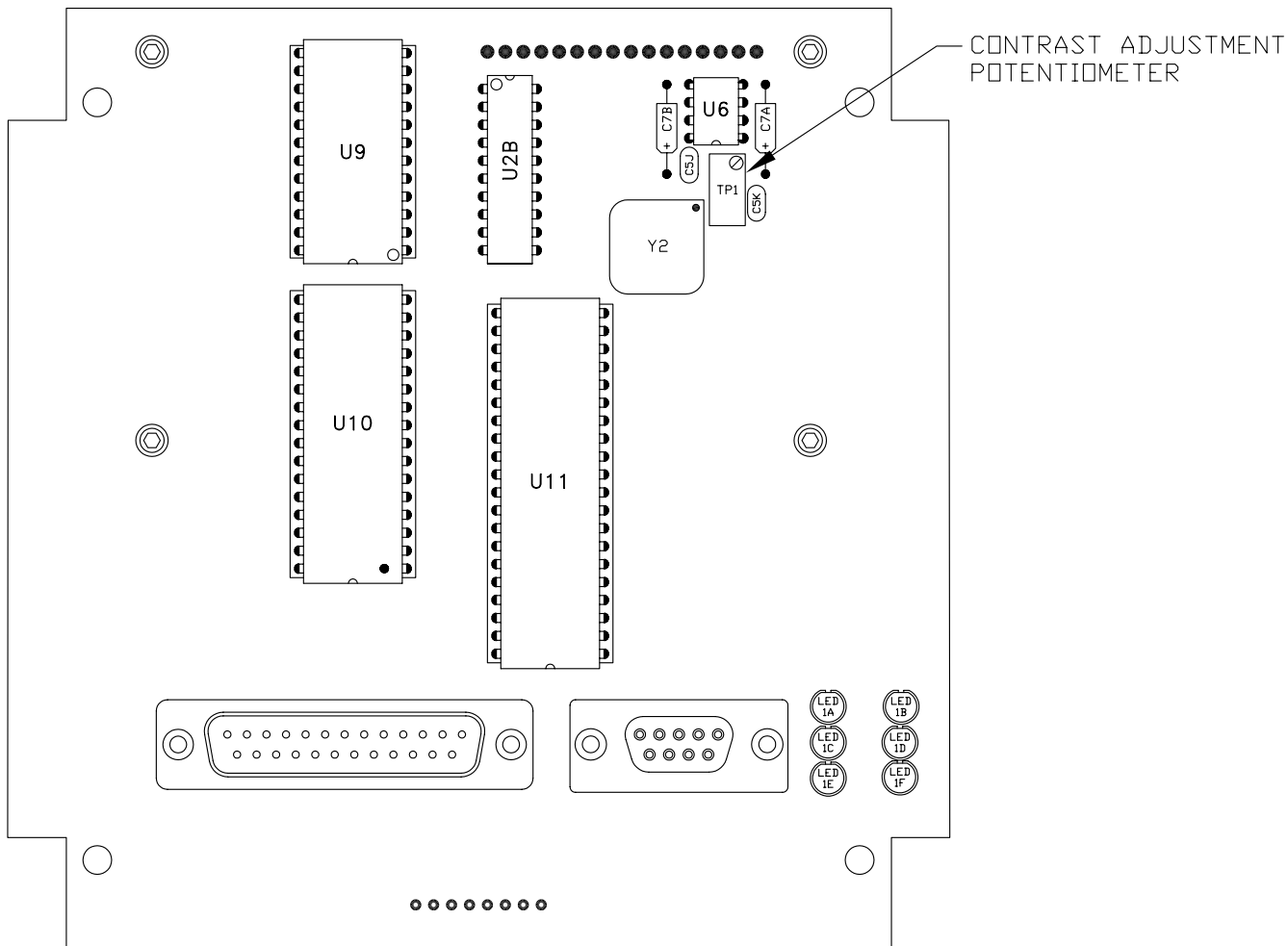

1. TO ADJUST LCD DISPLAY CONTRAST RATIO: USE AN ADJUSTING TOOL AND TURN THE POTENTIOMETER CLOCKWISE TO LIGHTEN THE CONTRAST RATIO OR COUNTERCLOCKWISE TO DARKEN THE CONTRAST RATIO. TO SET THE POTENTIOMETER BACK TO THE FACTORY SETTING; WITH THE DISPLAY MODULE AT AN AMBIENT TEMPERATURE OF APPROXIMATELY 65°F TO 77°F (18°C TO 25°C), TURN THE POTENTIOMETER COUNTERCLOCKWISE THREE TO THREE AND ONE HALF TURNS. THE DISPLAY SHOULD THEN BE AT A DESIRABLE CONTRAST RATIO.
2. U9 IS AN EEPROM. THIS IS WHERE THE USER CONFIGURED PROGRAM RESIDES.  
U10 IS A BATTERY BACKED RAM MODULE.  
U11 IS A MICRO CONTROLLER CHIP. THIS IS WHERE THE FIRMWARE RESIDES.